

FINAL THEORY OF DRIVING THE OFFICIAL HANDBOOK



FINAL THEORY OF DRIVING

THE OFFICIAL HANDBOOK

9th Edition

Final Theory of Driving
(Ninth Edition) is published
by Singapore Traffic Police.

No part of this publication
may be reproduced, stored in a
retrieval system, or transmitted
in any form or by any
means, electronic, mechanical,
photocopying, recording or
otherwise, without the prior
permission of the publisher:

Singapore Traffic Police

10 Ubi Avenue 3
Singapore 408865
T (65) 6547 0000
F (65) 6547 4900

**Published online by
Traffic Police**

Published on 01.07.2017

Note: The information contained
in this handbook is accurate
at the time of publication.
Candidates are advised to log in
to the TP website at [http://www.
police.gov.sg](http://www.police.gov.sg) & LTA website at
<http://www.lta.gov.sg> for the
latest updates.

CONTENTS

INTRODUCTION

The Safe Driver	4
Traffic Accidents	4
Systematic Learning	4

OPERATION OF VEHICLE CONTROLS

Names And Functions of Controls	5
Automatic Transmission	13
Selection And Control Of Drive	13
L (Lock-Up Or Hold)	14
Kick-Down	14
Switches And Their Usage	14
Meters And Warning Indicators	18
Seat And Seat Belts	21
Mirrors	22

BASIC DRIVING TECHNIQUES

Before Driving	23
Moving Off And Stopping	24
Changing Gears	29
Negotiating Bends	34
Changing Lanes	37
Driving Through Junctions	40
Driving Through A Roundabout	52
Overtaking And Being Overtaken	53
Stopping And Moving On Slopes	60
Reversing	62

CONTENTS

Vertical Parking	64
Directional Change	66
Parallel Parking	67
Emergency Stop	70
Narrow Courses	71

DRIVING IN TRAFFIC

Safe Driving Technique (Defensive Driving Technique)	75
Driving Uphill	82
Driving Downhill	83
Parking On A Slope	84
Interaction With Other Road Users	84
The Vehicle In Front	85
The Oncoming Vehicle	87
Traffic Jam	88
Stationary Vehicles	89
Obstacles	91
Pedestrians	92
Cyclists	97
Motorcyclists	98
Emergency Vehicles	99
Large Vehicles	99
Expressways	101
Emergencies	103
Loose Bonnet	103
Shattered Windscreen	104
Engine Overheating	104
Fire	105
Stuck Accelerator Pedal	105
Foot-Brake Failure	106
Loose Wheel	106
Tyre Blow-Out	106
Accidents	107

THE DRIVING TEST

Test Appointment	108
The Practical Test	108

RESTRICTIONS ON LEARNER DRIVERS 109

CONTENTS

VEHICLE MAINTENANCE

Daily Checks	111
Weekly Checks	111
Periodic Checks	111

LIGHT GOODS VEHICLES

Causes Of Accidents	112
Safety Devices	112

TRAFFIC LIGHT SURVEILLANCE CAMERA 113

COURTEOUS DRIVING 114

LAYOUT OF A DRIVING CIRCUIT 116

INTRODUCTION

THE SAFE DRIVER

- 1 A good driver is not merely one who is skilful in handling his/her vehicle competently but more importantly is one who is safe. In addition to being skilful, a good driver must also be patient, considerate and courteous. He/She must have a sense of responsibility for the safety of other road users and the ability to concentrate, anticipate and react appropriately while driving.
- 2 Safe driving calls for total awareness of what other road users are doing and the ability to “communicate” with them. The correct attitude towards driving will make the road a safer and more pleasant place for pedestrians and motorists alike.
- 3 During the initial stages of learning. It is essential that learner drivers cultivate the right qualities and learn the right techniques. Mistakes which are repeated will become habits which cannot be easily corrected.

TRAFFIC ACCIDENTS

- 4 Traffic accidents cause suffering, hardship and loss of lives. The motor vehicle, if not handled correctly, is potentially a lethal machine. Therefore, it must be driven with the awareness of the dangers that it can pose to life and limb.
- 5 Driving is a chain process involving perception, judgement and reaction. Since most accidents are due to poor perception and poor judgement on the part of drivers, accidents can thus be easily avoided if drivers were to anticipate and react in the proper manner. Proper planning and observation (perception), correct analysis and decisions (judgement of varying road traffic situations) are therefore essential if you were to avoid accidents.

SYSTEMATIC LEARNING

- 6 Learning rates differ from person to person. Therefore the number of training hours needed before one develops the right skills and attitude differs greatly from one individual to another. Learner drivers should adopt a planned approach. They must engage competent instructors who can phase each lesson systematically to suit their own development in the course of learning. They should practise regularly and relentlessly. There are no short cuts to becoming a competent and careful driver.

OPERATION OF VEHICLE CONTROLS

NAMES AND FUNCTIONS OF CONTROLS



(1) Steering Wheel	For controlling the direction of travel, as it operates only on the two front wheels
(2) Gear Lever For Manual Transmission Vehicle	For the changing of gears to regulate the power and speed of the vehicle
(3) Handbrake	For keeping the vehicle in a stationary position
(4) Accelerator Pedal	For regulating speed of vehicle
(5) Brake Pedal	For reducing speed or stopping
(6) Clutch Pedal	For transmitting or disconnecting engine power

Steering Wheel

- 7 Proper control of the steering wheel is fundamental to the balance and stability of the vehicle. It is therefore important to maintain maximum control of the steering wheel at all times. Two hands should be holding the steering whenever the vehicle is in motion.
- 8 The steering mechanism is self-centring and therefore requires only a light grip to keep the vehicle on a straight course. You may need to tighten your grip in order to maintain a proper course while cornering, braking and on uneven roads such as gravel paths, muddy tracks and road humps.

OPERATION OF VEHICLE CONTROLS

- 9 There are two recommended methods of holding the steering wheel. Choose the position that is more comfortable.
- (a) Hold the steering wheel with both hands at either the 'ten-to-two' or 'quarter-to-three' position.



**"Ten-to-two"
Position**



**"Quarter-to-three"
Position**

- (b) Do not release the steering wheel and allow it to spring back after you have made a turn.
- (c) Do not move your body when turning the steering.
- 10 The correct amount of steering adjustment and the correct speed at which it should be done to suit varying road conditions and to negotiate bends can only come with constant practice.
- 11 The steering wheel should be turned to suit the curvature of the road. Drivers should always look far ahead for varying road conditions so that adjustments to steering grip and vehicle speed can be made before turning.
- 12 While negotiation a gradual bend, turn the steering wheel gradually without shifting the position of both hands. After the bend, turn the steering wheel back to its original position to resume a straight course.
- 13 When negotiating a sharp bend, several turnings of the steering wheel may be required. You should always remember not to cross your hands when turning the steering wheel. After the bend, you should quickly turn the steering wheel back to its original position to resume a straight course.
- 14 When reversing, the vehicle response to the steering wheel is not as sensitive as when you are driving forward. As a result, learner drivers have a tendency to oversteer when reversing.

OPERATION OF VEHICLE CONTROLS

- 15 Steering a vehicle in reverse is similar to driving forward. You should steer in the direction in which you wish to move.

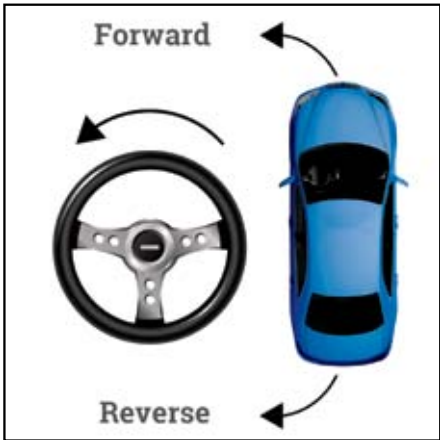

(a) When the steering wheel is turned to the left, the vehicle will move forward or reverse to the left.

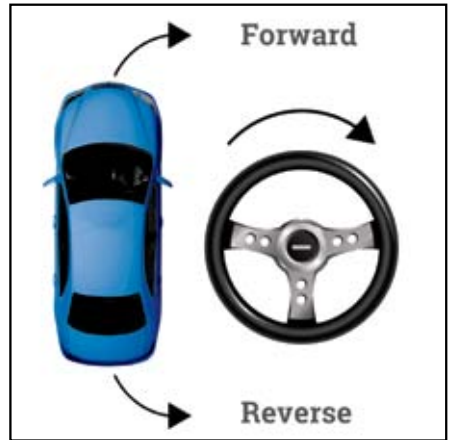

(b) When the steering wheel is turned to the right, the vehicle will move forward or reverse to the right.

Gear Lever For Manual Transmission Vehicle

- 16 The gear lever helps you to select the gears to move the vehicle forward or backward. The gear-box usually houses five forward gears and a reverse gear. Generally, the gears control the speed and power of the vehicle.

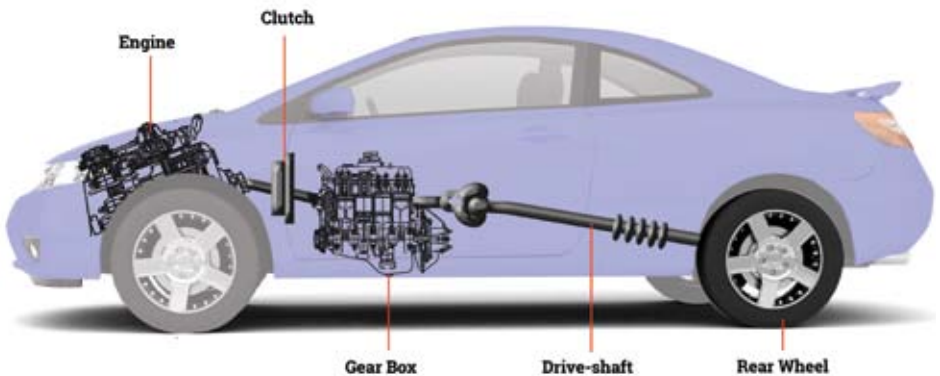

OPERATION OF VEHICLE CONTROLS

- 17 The markings on the knob of the gear lever indicate the position and direction in which the lever should be shifted in order to engage the respective gears.

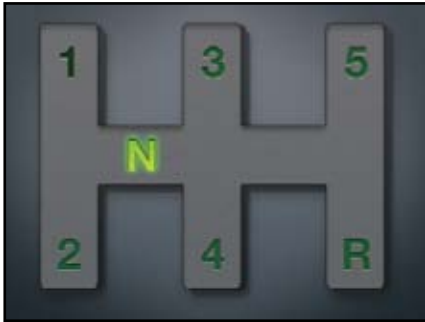

- (a) **N...Neutral**
With the lever in the Neutral N position, the vehicle is not in gear and will not move when you accelerate because power from the engine is not transmitted to the wheels.
- (b) **1...1st gear**
The 1st gear has the lowest speed range (10 km/h to 20 km/h) and is used for moving a vehicle from a stationary position, driving on steep slopes and travelling at a very slow speed.
- (c) **2...2nd gear**
The 2nd gear has a slightly higher speed range (15km/h to 35Km/h) than the 1st gear. It is used for travelling at low speeds, negotiating sharp corners and driving on steep slopes.
- (d) **3...3rd gear**
The 3rd gear has a moderate speed range (30km/h to 45km/h). It is used for negotiating bends and driving on low gradient slopes.
- (e) **4...4th gear**
The 4th gear has the highest speed range 40km/h and upwards. It is used for cruising.
- (f) **5...5th gear**
Some vehicles have fifth gear known as 'overdrive' It is used when the vehicle is cruising at speed above 70 km/h.
- (g) **R... Reverse gear**
The reverse gear is for moving the vehicle backwards.
- 18 To shift the gear lever, cup your left palm over the gear lever knob with the palm facing the direction in which you intend to shift the gear lever. When changing gears, the clutch pedal should be fully depressed.

OPERATION OF VEHICLE CONTROLS



(a) Neutral

To check that the gear is in Neutral, hold the gear lever knob and move the gear lever from side to side. The lever should move freely.



(b) Neutral to 1st Gear

To engage the 1st gear, shift the gear lever to the left and push it forward.



(c) 1st to 2nd Gear

To change from 1st and 2nd gear, pull the gear lever downwards in two motions with a slight pause at Neutral.

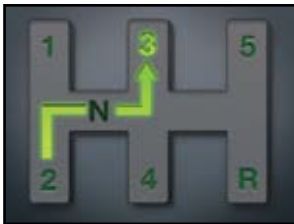

(d) 2nd to 3rd Gear

To change from 2nd to 3rd gear, push the gear lever to Neutral, shift it to the right and push forward.



(e) 3rd to 4th Gear

To change from 3rd to 4th gear, pull the gear lever downwards in two motions with a slight pause at Neutral.

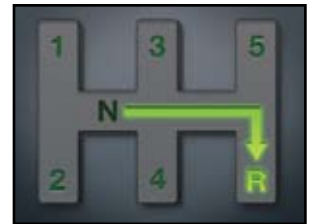

(f) Reverse Gear

To engage the Reverse gear, shift the gear lever to the extreme right with more pressure than you would with the 4th gear and pull it downwards.

- 19 The process of changing gear from 1st to 2nd, 2nd to 3rd and onwards is known as 'changing-up'. This is to enable the vehicle to pick up speed smoothly from rest. Conversely, when you reduce the speed of your vehicle, the gears should be 'changed-down' accordingly.

Handbrake

- 20 The handbrake is sometimes referred to as the 'parking brake'. It operates only on the two rear wheels and should be used to prevent the vehicle from rolling forward or backward when the vehicle is parked or stationary and when the vehicle comes to a halt at the traffic light junction. It should not be used to stop the vehicle while driving, except in an emergency. For example, when your footbrake fails to work.

OPERATION OF VEHICLE CONTROLS

- 21 To apply the handbrake, depress the footbrake pedal, press the button at the top end of the lever with your thumb to release the catch and pull the lever upward.



- 22 To release the handbrake, depress the footbrake pedal, pull the lever slightly upward, press the lever button and lower the lever down fully. Do not release the button until you have brought the lever to the OFF position.



Accelerator Pedal

- 23 The accelerator pedal is the most 'sensitive' pedal. It controls the supply of fuel-air mixture to the engine. A slight change of pressure on the pedal will bring about a big change in the engine revolution. The accelerator pedal is therefore sensitive. Accurate control of the pedal is essential to ensure a smooth start and a comfortable journey.
- 24 This pedal is operated with the outer edge of the ball of the right foot, (i.e. the portion nearer to the toes) with the heel resting on the floor board. However, the pedal should be momentarily released whenever the clutch pedal is depressed for the purpose of engaging gears.
- 25 The accelerator pedal must be depressed steadily and progressively in order to achieve a gradual and smooth increase in speed.

Brake Pedal

- 26 The brake pedal is used to slow the vehicle down and eventually bring it to a stop. It should be applied firmly during the initial stage with pressure on the brake gradually reducing as the vehicle approaches its destination.



(a) You should use the ball of your right foot to depress the brake pedal.



(b) Your heel should not touch the floor board when the brake pedal is being used.

OPERATION OF VEHICLE CONTROLS

27 The safest way of braking is to employ the 'intermittent braking' (ON/OFF) technique. This method of braking should not be done when stopping the vehicle in an emergency. The technique of intermittent braking is to depress and release the brake pedal 2 or 3 times before bringing the vehicle to a complete stop.

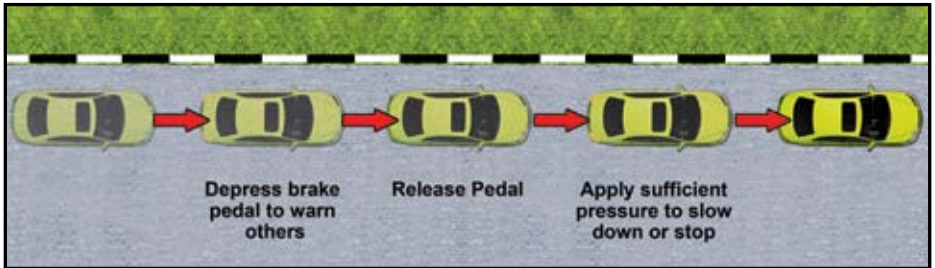

28 The advantages of this technique are:

- (a) It gives adequate warning to motorists following behind;
- (b) It prevents the wheels from locking which can cause skidding;
- (c) It dries the brake after passing through flood (pump the brake repeatedly until braking effect returns).

Clutch Pedal

29 The clutch pedal is used to engage and disengage the clutch. When the pedal is fully depressed, the clutch is disengaged. Engine power is not transmitted to the gear-box.

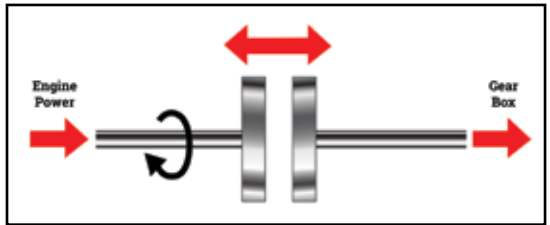

30 When the pedal is fully released, the clutch is engaged. Engine power is transmitted to the gear-box.

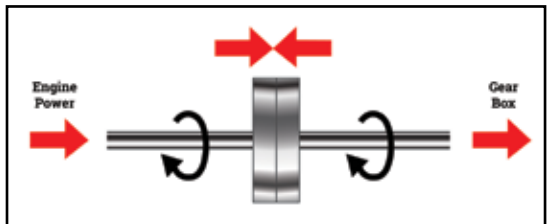

OPERATION OF VEHICLE CONTROLS

31 You should depress the clutch pedal whenever you wish to:

- (a) Engage the gear (1st or reverse gear) when starting from rest;
- (b) Change to another gear when the vehicle is in motion;
- (c) Come to a stop;



(d) You should use the ball of your left foot to press the clutch pedal;



(e) Your heel should not touch the floor board when the clutch pedal is being used;

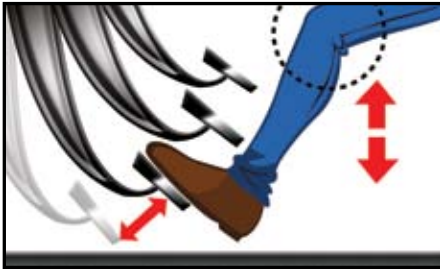

(f) You should use knee movement to depress or release the clutch pedal;



(g) You should place your foot on the floor board immediately after use.

AUTOMATIC TRANSMISSION

- 32 A vehicle with automatic transmission has no clutch pedal. It has instead a system that senses the need for changes to higher or lower gears, and makes such changes for itself. The transmission senses and selects the gear according to the road speed and load on the engine, thus a driver does not have to worry about the repeated decisions and movements involved in normal gear changing. This makes the physical job of driving much easier and it also allows a driver more time to concentrate on what is happening on the road.
- 33 Generally, an automatic transmission changes to a higher gear as road speed rises and to a lower one as it falls. It also takes into account the load on the engine so that (for example) it changes down, if necessary, for uphill work. However, there are times when you need a low gear although your speed is constant and the engine load is light – such as when you are going down a long steep hill, the automatic transmission will not necessarily choose the right gear in these situations, thus you need to know how to use the particular types of controls fitted to your car to your best advantage.



SELECTION AND CONTROL OF DRIVE

- 34 Most automatics have a small selector lever, and there is usually one position or setting which corresponds to neutral on an ordinary gearbox (one type, dealt with later, is an exception.) With the engine running, the selector can be moved between driving and reversing positions.
- 35 There are four positions that are basic to most types of automatics; they are often labelled 'P' for Park, 'R' for Reverse, 'N' for Neutral and 'D' for Drive, and arranged in that order.
- 36 Having started the engine with the selector at P (Park), then with the lever moved to D (Drive), you need only release the brakes and press the accelerator pedal for the car to move forward. The car will then continue moving, changing gears as necessary, as long as there is enough pressure on the accelerator pedal. When there is insufficient pressure on the accelerator pedal, the car will slow down, change down and eventually stop (except downhill).
- 37 Also, because an automatic transmission is sensitive to both speed and load on the engine, heavy acceleration delays upward gear changes until the car has built up more speed. This is because hard acceleration on a flat road can put as much load on the engine as climbing a steep hill. The automatic mechanism measures the load and then changes gear accordingly. With most automatics, the lower the speed, the smoother the gear changes.

OPERATION OF VEHICLE CONTROLS

L (Lock-Up Or Hold) / Kick-Down / Switches And Their Usage

L (LOCK-UP OR HOLD)

- 38 The 'L' (Lock-up or Hold) position on the selector enables you to either keep in a low gear or to use a lower gear. In heavy and slow traffic, you might find that using D may cause unnecessary upward and downward automatic gear changes. Using L would override the automatic mechanism and keep you in the lower gear.
- 39 Similarly, if you want to change to a lower gear – for example, to go down a long steep hill – you need to use L. Many automatic transmissions have three forward gears and the L position is usually arranged to allow you to select or to hold either the middle or the lowest of these.
- 40 With most types of automatics, if you select L when in second gear, it will hold that gear only at speeds above about 10 kmph. If the speed drops so low that the bottom gear comes in, the L position will then hold the transmission down to that gear. In other words, there will be no change back to second gear – unless, of course, you select D again. The lock-up arrangements on some versions of automatics allow any gear to be selected and held; on others, any gear except the top gear may be held.

KICK-DOWN

- 41 Many automatics have a form of foot control called 'kick-down'.
- 42 A short sharp pressure right down on the accelerator pedal, past the fully open position, causes a quick change down to the next lower gear.
- 43 This ability to override the automatic mechanism is very useful for quick acceleration when you need it – e.g. for overtaking. To return to the higher gear again, merely ease the pressure on the accelerator pedal.

SWITCHES AND THEIR USAGE



- (a) Ignition switch (or starter switch)
- (b) Direction indicator lever
- (c) Windscreen wiper and washer
- (d) Horn
- (e) Light switch
- (f) Hazard warning switch
- (g) Demister

Ignition Switch (Or Starter Switch)

44 Before starting the engine, ensure that the handbrake is applied. For auto transmission vehicles, ensure that the gear lever is at 'P' (Parked) position.

- (a) To start the engine, turn the ignition key in a clockwise direction to the START position.
- (b) To switch off the engine, turn the ignition key in an anti-clockwise direction to the OFF position.
- (c) To withdraw the key, turn it further to the LOCK position. (Note that the key can only be removed with the engine off).

LOCK - The steering wheel is locked when the key is not inserted. Insert the key and turn it in a clockwise direction to unlock the steering wheel.

OFF - Engine and accessories are off. The steering wheel is free.

ACC - Electric current flows to accessory fixtures.

ON - Electric current flows to ignition system.

START - Starter motor begins to rotate. Once the engine is started, quickly release the key. It will automatically return to the 'ON' position.



OPERATION OF VEHICLE CONTROLS

Direction Indicator Lever

45 The direction indicator switch is used to indicate to other motorists the direction in which you wish to proceed. When the switch is operated, yellow indicator lights situated at each end of the front and rear of the car will flash on and off. When making a turn, shift the lever in the direction in which you wish to turn. When the turn is completed, the lever will automatically return to its original position.

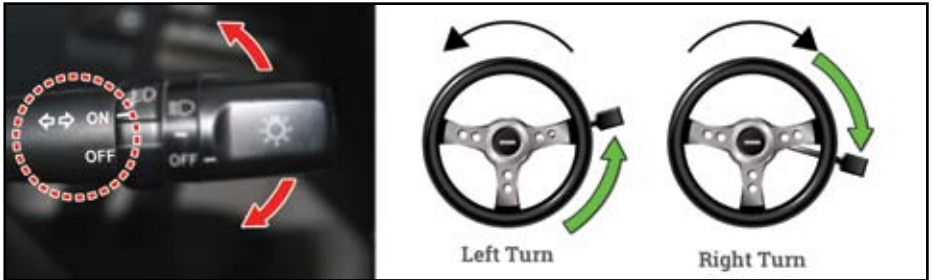

Windscreen Wiper And Washer

46 To operate the windscreen wiper, move the lever downwards to any of the wiper speed positions of your choice. The windscreen washer is operated by pulling the lever towards you or pushing the button at the end of the lever.

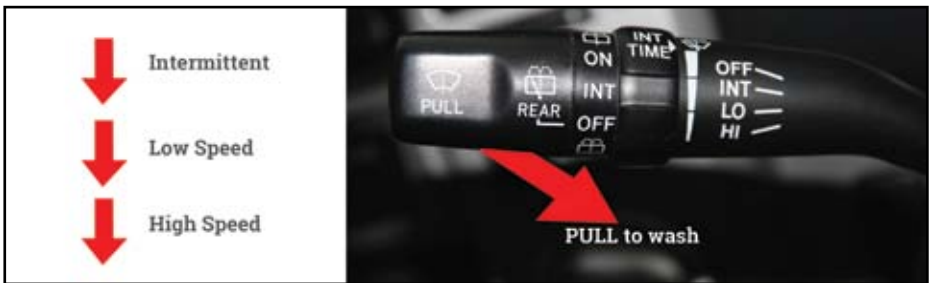



Horn

47 The horn is usually located at the cross bar of the steering wheel. It is used to warn other road users of any impending danger.



OPERATION OF VEHICLE CONTROLS

Light Switch

- 48 The light switch is usually located at the end of the Direction Indicator Lever. All drivers are required to switch on their headlights while driving from 7.00 pm to 7.00 am. However, during the day in reduced day light, switch on your headlights. Switching them on makes you more conspicuous to other motorists.
- 49 The light switch is operated by turning it in a clockwise direction. When it is turned to this  position, the parking, tail, number plate and instrument panel lights should come on. At this  position, the headlights and all the above lights should come on together.
- 50 There are two positions for the headlights; the high beam and the low beam.
- 51 At night when visibility is poor, turn on the high beam by pushing the lever forward. In built-up areas or when facing oncoming vehicles, pull the lever backward to switch to the low beam.



Hazard Warning Switch

- 52 This switch turns on the four direction indicator lights simultaneously. These serve as warning lights to warn other motorists when your vehicle breaks down. It can also be used when stopping momentarily at the side of the road.



Demister

- 53 When the switch is turned on, it activates the demister on the rear windscreen of your vehicle. Heat is generated and directed over the screen to clear condensation and prevent misting.



OPERATION OF VEHICLE CONTROLS

METERS AND WARNING INDICATORS

54 Meters and Warning Indicators include:

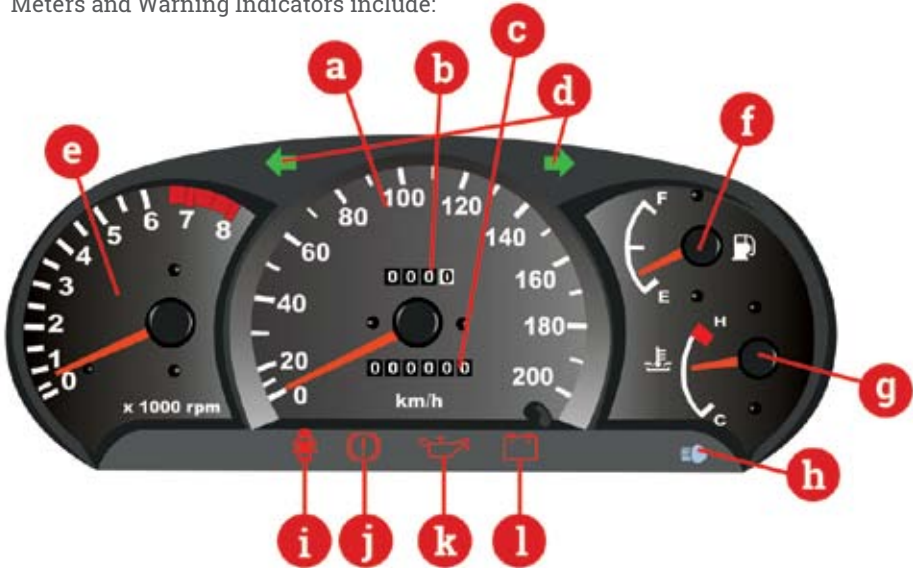

- (a) Speedometer
- (b) Trip Odometer
- (c) Odometer
- (d) Signal Indicators
- (e) Tachometer or Rev Counter
- (f) Fuel Gauge
- (g) Temperature Gauge
- (h) High Beam Indicator
- (i) Door Warning Light
- (j) Brake Warning Light
- (k) Oil Pressure Warning Light
- (l) Battery Warning Light

Speedometer

55 Indicates the speed at which you are travelling.

Odometer

56 Records the mileage travelled.

Trip Odometer

57 This meter can be reset to record mileage travelled per trip.



OPERATION OF VEHICLE CONTROLS

Signal Indicators

58 The indicator lights will flicker when the indicator is activated in the desired direction. However, when the hazard lights are switched on, both signal indicator lights will flash on and off simultaneously.



Tachometer Or Rev Counter

59 Indicates the number of engine revolutions per minute.



Fuel Gauge

60 The pointer indicates the amount of fuel in the fuel tank.



Temperature Gauge

61 The pointer of the gauge will move from C to H as the temperature of the engine rises. If the pointer swings beyond the normal range, it means that the engines is over-heating.



High Beam Indicator

62 This light will come on when the headlight switch is turned to the high beam position.

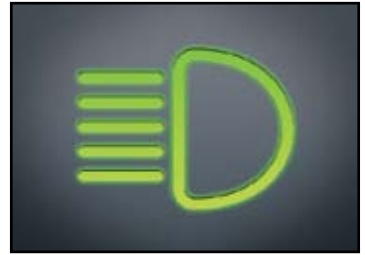

Door Warning Light

63 This light will come on when any of the doors is not properly shut.



Brake Warning Light

64 The brake warning light will come on when the ignition key is switched to the ON Position and goes off once the handbrake is released. When it remains on, it means that either the brake fluid in the brake fluid reservoir is below the prescribed level.



Oil Pressure Warning Light

65 This light will come on when the ignition is switched to the ON position. If the light fails to go off after the engine is started, this indicates that the lubricating oil in the engine is below the prescribed level.



Battery Warning Light

66 This light will come on when the ignition key is switched to the ON position. It will go off once the engine is started. If the light fails to go off after the engine is started, it means that the battery charging system is faulty.



SEAT AND SEAT BELTS

67



(a) Sit upright and lean against the backrest with both hands comfortably holding the steering wheel. Arms should be slightly bent.



(b) Adjust your seat so that your left leg is almost straightened when the clutch pedal is fully depressed.

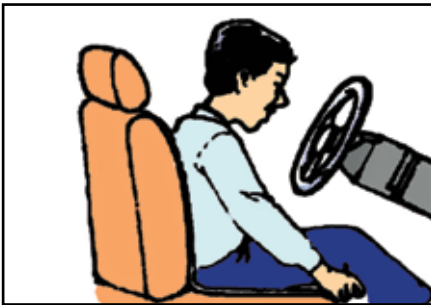

(c) If necessary, use a cushion to obtain the correct sitting position.

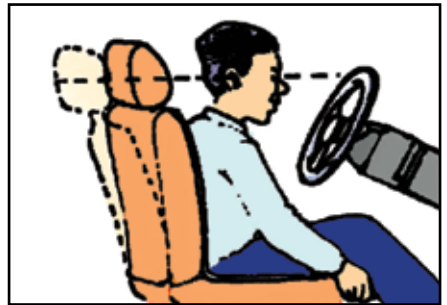

(d) Adjust the headrest so that it forms a straight line with your ear and eye. This prevents neck injuries in a collision from the rear.



(e) Fasten the seat belt only after you have adjusted the seat and are in the correct driving posture.



(f) For the non-retractable type of seat belt, the slack should not be more than a clenched fist space between the shoulder belt and your chest.

MIRRORS

68 Adjust the mirrors when you are properly seated with the seat belt secured.



(a) Hold the edge of the rear view mirror and adjust it so that you have a good view of the rear through the rear windscreen.



(b) Adjust the side mirror until the horizon is slightly above the centre line. Part of the body of your vehicle should be seen in the mirror.

69 There are two areas on the right and left of your vehicle which cannot be viewed from your mirrors. These are known as 'blind spots'. You have to turn your head and look over your shoulder to the left or the right to check for traffic in the 'blind spots' before changing lane, overtaking and turning.

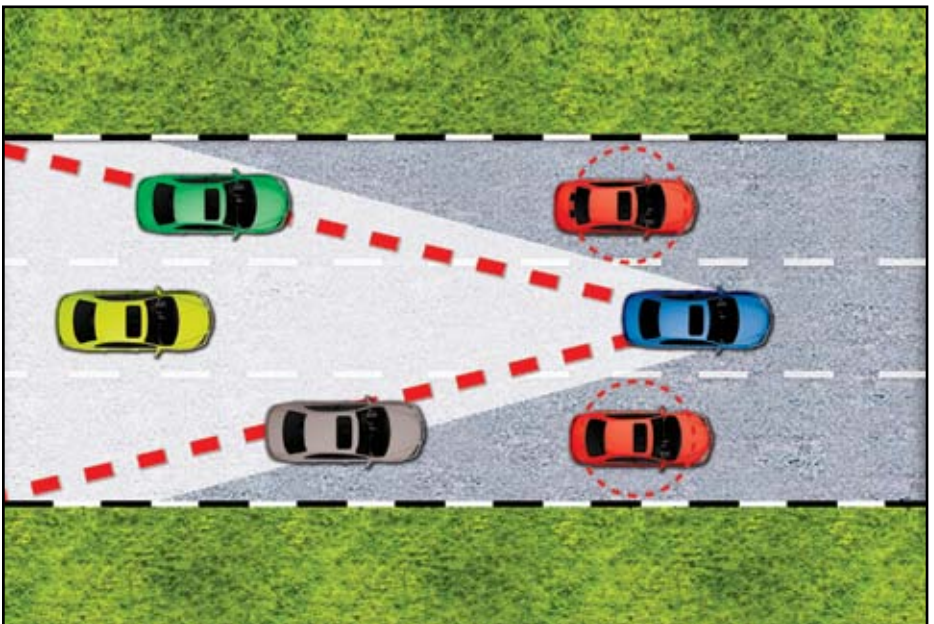

BASIC DRIVING TECHNIQUES

BEFORE DRIVING

- 70 Precautionary measures should be taken by doing a simple routine check on your vehicle. This will save you a lot of unnecessary inconvenience and make your journey a trouble free one.
- 71 A responsible driver would always make it a habit to walk round his/her vehicle to check if:
- (a) there is any damage to the body of the vehicle, including registration plates and all the light fittings;
 - (b) the tyres are properly inflated and there are no punctured tyres.
- 72 Plan your route by referring to a street directory and accessing traffic information via the internet or radio broadcast.
- 73 Wear proper attire when driving.



- 74 When opening the door of your vehicle:
- (a) Pay attention to the vehicles approaching from behind;
 - (b) Do not open the door too widely;
 - (c) If the traffic is heavy, use the kerb-side door;
 - (d) Once you are inside the vehicle, lock the doors.
- 75 Adjust your seat so that all controls can be reached without the need to stretch. Fasten your seat belt, adjust your rear and side view mirrors and ensure that the handbrake is fully on. Insert your cash card in advance for ERP (Electronic Road Pricing) and parking payments.

BASIC DRIVING TECHNIQUES

MOVING OFF AND STOPPING

76 Beginners are advised to use a driving circuit for safety. If a driving circuit is not available, choose a non-prohibited quiet area to practise these basic driving techniques.

77 Before driving off, sit in the driver's seat and look around. This is to enable you to get a feel of the vehicle's dimensions.

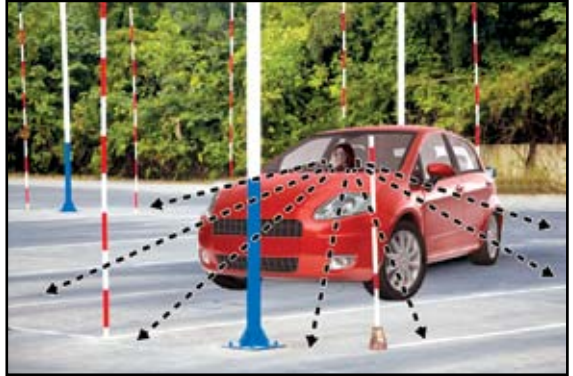

78 Keep in mind the view you have seen from the driver's seats. Next, get out of the car and observe the length and width of the vehicle. You will notice that the actual width of the road required is not as wide as what you think you will need.



79 When driving, estimate the width of the road required for your vehicle to pass through by using the lane markings and your sense of judgement.



BASIC DRIVING TECHNIQUES

80 To move off , follow the steps below:

- (a) Check that the gear lever is in the Neutral position for a manual car and 'P' (Parked) position for an auto car;
- (b) Slightly depress the accelerator pedal and turn the ignition key to the START position to start the engine;
- (c) Release the accelerator pedal once the engine is started and the engine will rotate at 'idling speed';
- (d) Look out for other road users in front and behind. This will enable you to discern any immediate hazard(s) present at that moment;
- (e) Signal your intention;
- (f) Depress the clutch pedal and engage the first gear;
- (g) Slightly depress the accelerator pedal and at the same time slowly release the clutch pedal;
- (h) When the clutch pedal is released about half-way, you will notice a slight drop in the engine revolution. The clutch is now at the 'biting point'. Maintain the clutch at this position. This is known as the 'half-clutch' position;
- (i) Confirm that it is safe to move off by taking a side glance at the blind spots by looking over your shoulder;
- (j) Release the handbrake;
- (k) Depress the accelerator pedal further and at the same time slowly release the clutch pedal. The vehicle will start to move;
- (l) Let the vehicle attain the speed of a walking man;
- (m) Fully release the clutch pedal;
- (n) Depress the accelerator pedal to pick up speed;
- (o) Look far ahead, the distance (in meters) you should look at must be at least three times the speed (in km/h) at which you are travelling;



BASIC DRIVING TECHNIQUES

- (p) Observe your course. When you feel that the vehicle is moving to one side, adjust the steering wheel slightly to maintain a straight course;

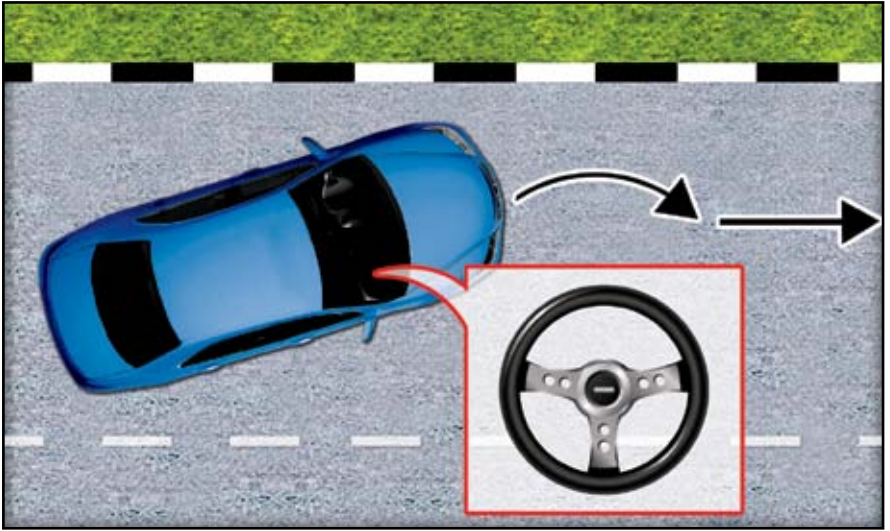

- (q) If you cannot drive straight due to an uneven surface, reduce your speed.

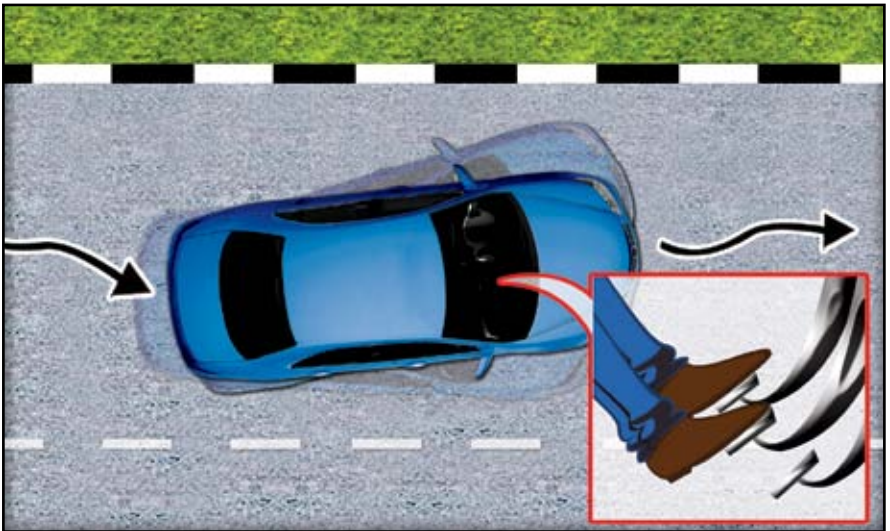

BASIC DRIVING TECHNIQUES

81 The control of both the clutch and the accelerator pedals will pose some problems to learner drivers at the initial stage. Proficiency will come with practice. Listed below are common problems learner drivers have in moving off.

PROBLEM	CAUSES
(a) Engine vibrates violently	The accelerator pedal is insufficiently depressed and/or is in the incorrect half-clutch position (clutch pedal over-released).
(b) Vehicle jumps and jerks or surges forward	The accelerator pedal is depressed excessively and/or the clutch pedal is released suddenly.
(c) Engine stops suddenly	The accelerator pedal is insufficiently depressed and / or the clutch pedal is released too suddenly.

82 When stopping, you must consider the speed of your vehicle and the distance ahead. Always depress the brake pedal early and prepare to stop slightly before the targeted stopping position. Continue practising until you can stop exactly where you want to.

83 You must always bear in mind the following when stopping:

- (a) Look out for other road users in front of you;
- (b) Use the rear view mirror to check the traffic behind;
- (c) Signal your intention;
- (d) Check your left blind spot;
- (e) Release the accelerator pedal;
- (f) Move to the left edge of the road;
- (g) Gently depress the brake pedal;
- (h) Fully depress the clutch pedal when the vehicle is about to stop;
- (i) Keep both the clutch and brake pedals depressed;
- (j) Pull up the handbrake and shift the gear lever to the Neutral position.

84 If the clutch pedal is depressed too late when stopping the vehicle, the engine will stall. As a result of this, learner drivers tend to depress the clutch pedal too early to overcome this problem. Depressing the clutch pedal too soon will cause the vehicle to be 'free-wheeling'. This is especially dangerous when you are stopping your vehicle at high speeds and when cornering at a high speed.

85 The clutch pedal should be depressed at the precise moment just before the engine begins to vibrate. Experience will enable you to decide the appropriate moment.

86 When leaving the vehicle, you should:



(a) Switch off the engine and withdraw the ignition key;



(b) Unfasten the seat belt;



(c) Unlock the door and hold it slightly ajar to ascertain if it is safe for you to open it;



(d) Slowly open the door and get out of the vehicle;



(e) Close the door firmly;



(f) Lock all doors before leaving the vehicle.

CHANGING GEARS

87 To select the suitable gear, note the speed of the vehicle by the sound of the engine, the moving scenery outside and an occasional glance at the speedometer.

88 Follow the drill below when changing up:

1st Gear

- (a) Depress the clutch pedal;
- (b) Engage the 1st gear;
- (c) Release the clutch pedal half-way and depress the accelerator pedal slightly at the same time;
- (d) Release the clutch pedal further and accelerate to gain speed;
- (e) Accelerate evenly until the vehicle reaches the speed of about 15-20 km/h.

2nd Gear

- (f) Depress the clutch pedal and at the same time release the accelerator pedal;
- (g) Shift the gear lever from the 1st to 2nd position;
- (h) Release the clutch pedal half-way, then further release it slowly and at the same time depress the accelerator pedal;
- (i) Accelerate evenly to about 30-35 km/h.

3rd Gear

- (j) Depress the clutch pedal and at the same time release the accelerator pedal;
- (k) Shift the gear lever from the 2nd and 3rd position;
- (l) Release the clutch pedal continuously in one motion and at the same time depress the accelerator pedal;
- (m) Accelerate evenly to about 40-45 km/h.

4th Gear / 5th Gear

- (n) The procedure is the same as with the 3rd gear. Once the 4th gear is engaged, accelerate gradually to normal cruising speed at 5th gear.

89 Gear changing involves frequent movements of hand and feet. Learner drivers tend to look down at the gear lever, pedals and feet while trying to co-ordinate them. Once this bad habit is formed, it is difficult to correct. It is dangerous to take your eyes away from the road, even for a little while, whilst driving.

90 This chart shows the approximate speed range of each gear.

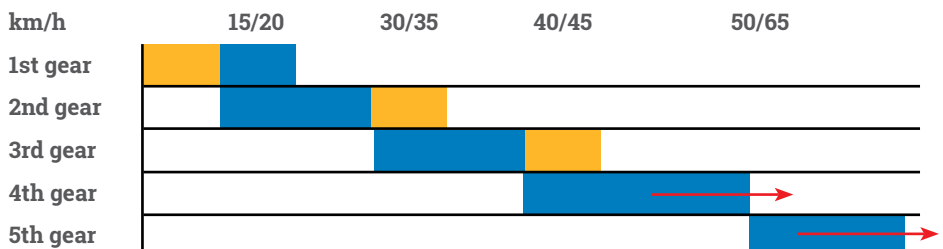

- 91 If at any time, traffic conditions do not permit you to accelerate to the required speed in order to change up to the next higher gear, you should control the accelerator pedal and adjust your speed to suit traffic conditions. You should change up when conditions permit.
- 92 When the speed of the vehicle is reduced to below the speed range of the particular gear you are using, it is necessary to change down to the next lower gear i.e. from the 4th to the 3rd gear or from the 3rd to the 2nd gear. Follow the steps below when changing down:
- (a) Release the accelerator pedal and at the same time depress the clutch pedal;
 - (b) Shift the gear lever to the next lower gear;
 - (c) Gently release the clutch pedal and at the same time depress the accelerator pedal according to the speed of the vehicle;
 - (d) If the vehicle is slowing down to almost a stop, engage the 1st gear;
 - (e) If the speed of your vehicle has dropped drastically, the next lower gear may not have the required power to keep your vehicle going smoothly. You should therefore 'change down' to the appropriate gear, i.e. from the 4th to the 2nd gear or from the 3rd to the 1st gear.
- 93 We do not react instantly to what we see because we need to analyse what we see in order to decide on the appropriate action to take. Therefore you should always adjust your speed to give yourself sufficient time to perceive, decide and react to the ever changing traffic situations.

An Example Of Analytical Driving

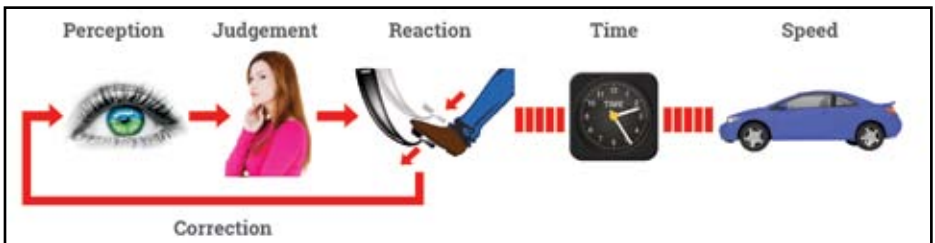

- 94 First Analysis



95 Second Analysis



96 Third Analysis



- 97 When bringing your vehicle to a smooth and safe stop from top-gear (4th or 5th gear), you should do the following:
- Look ahead for a safe place to stop;
 - Check the rear view mirror for traffic behind you;
 - Signal your intention;
 - Check your blind spot;
 - When it is safe, pull over to the edge of the road;
 - Adjust the pressure on the brake pedal so that it is greater during the initial stage and lighter as the vehicle approaches its destination.

BASIC DRIVING TECHNIQUES

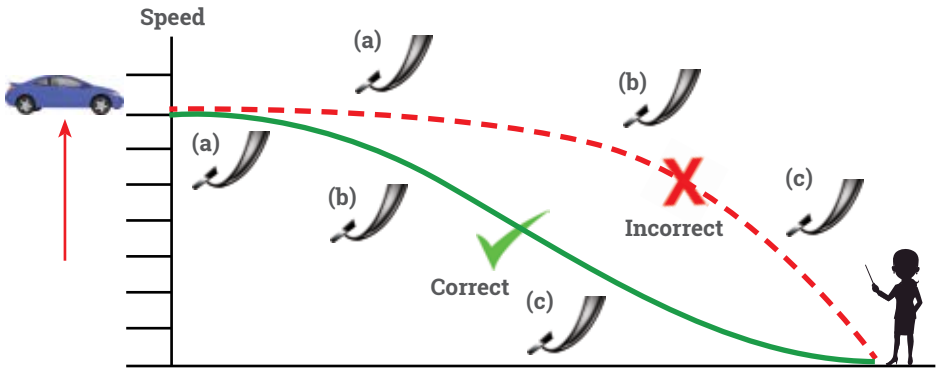

CORRECT BRAKING	INCORRECT BRAKING
(a) Depress early	(a) Depress late
(b) Depress hard	(b) Depress hard
(c) Reduce pressure gradually	(c) Increase pressure further

98 When your vehicle is in motion and the pressure on the accelerator pedal is suddenly taken off, the reduction in engine revolution will produce a braking effect on the wheels. This effect is known as 'engine-brake'.

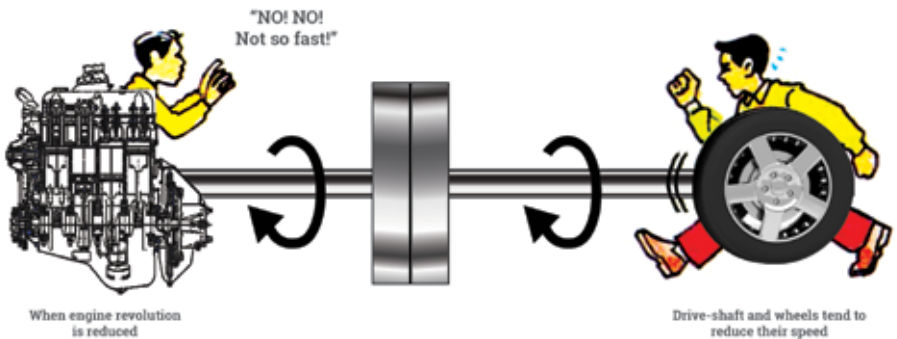

BASIC DRIVING TECHNIQUES

99 The engine-brake will no longer be effective when the clutch pedal is depressed.

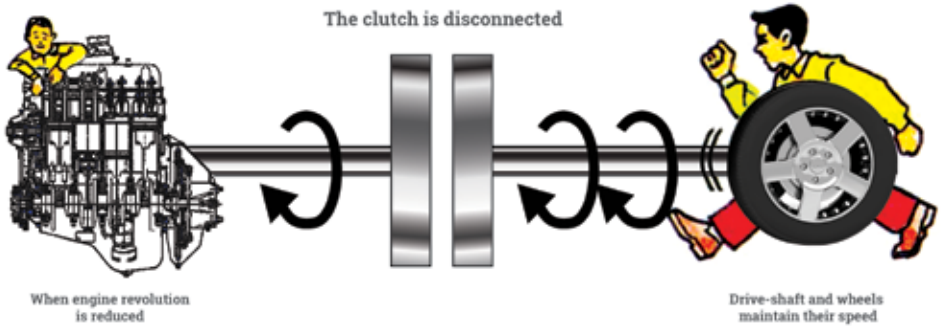

100 The lower the gear, the more effective the engine-brake. This is especially useful when driving down a hill where there is a need to control the speed of descent of your vehicle.



(a) Use the 3rd gear
When the slope
is gradual



(b) Use the 2nd gear
When the slope
is steep



(c) Use the 1st gear and
the footbrake together
When the slope is
short and steep

101 The advantages of applying the engine-brake are:

- (a) More effective braking when done together with the footbrake;
- (b) The vehicle is unlikely to skid when braking;
- (c) The brake-linings of your vehicle will not 'fade' when braking down a long steep slope.

NEGOTIATING BENDS

102 When negotiating a bend, observe:

- (a) Your speed and distance before entering the bend;
- (b) The curvature of the bend;
- (c) The traffic situation ahead.

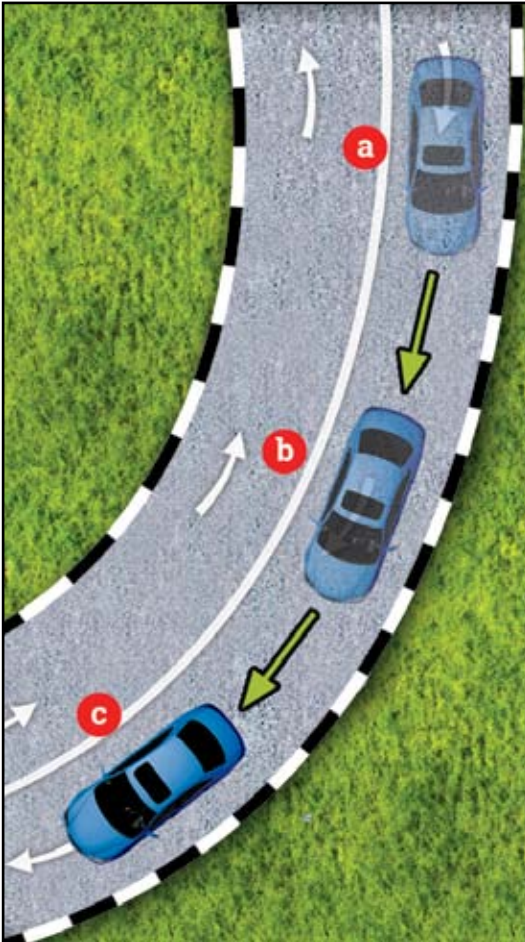

103 Decide on:

- (a) A suitable speed and gear for the vehicle;
- (b) The path of travel you intend to take;
- (c) The appropriate action to take after the bend.

104 Negotiate a gradual bend in the following manner:

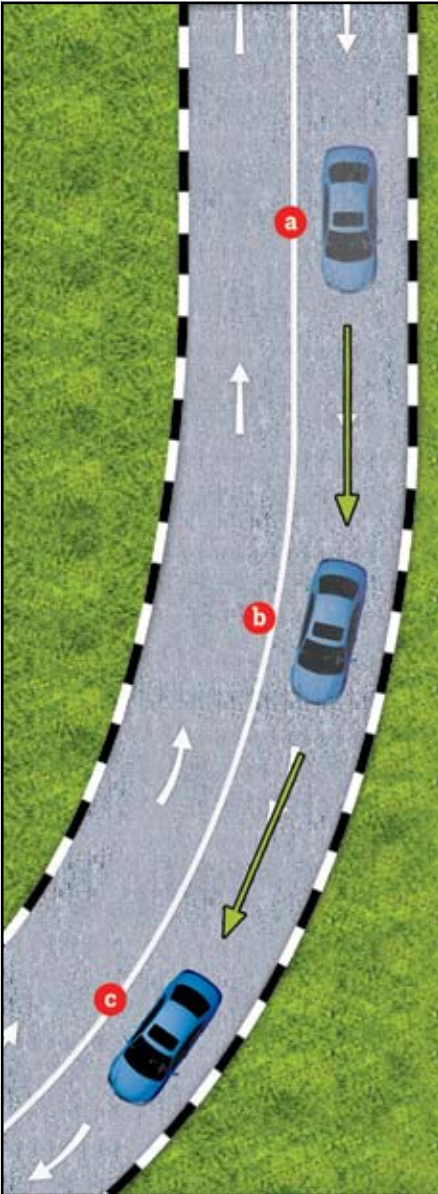

At 'a'

- (i) Consider your speed and distance on approaching the bend;
- (ii) Release the accelerator pedal;
- (iii) Change to a lower gear (usually the 3rd gear).

At 'b'

- (i) Depress the accelerator pedal lightly to maintain a steady speed;
- (ii) Maintain position of the vehicle in your lane, preferably in the centre;
- (iii) Do not shift your body while turning the steering wheel.

At 'c'

- (i) Look far ahead;
- (ii) If the traffic situation is favourable, accelerate quickly as the steering wheel is returning to its original position;
- (iii) Change to a higher gear.

105 To negotiate a sharp bend follow the steps below:

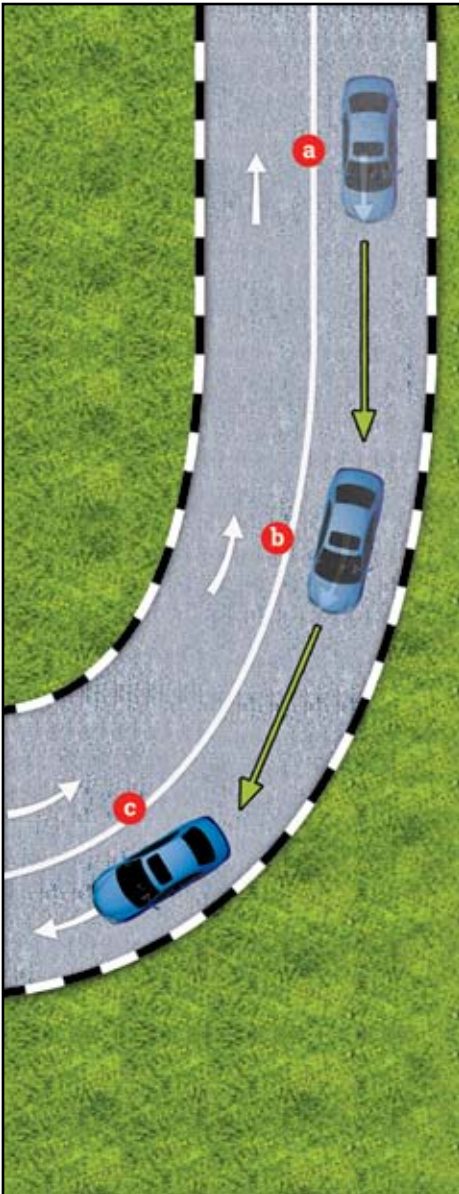

At 'a'

- (i) Consider your speed and distance from the bend;
- (ii) Release the accelerator pedal;
- (iii) Depress the brake pedal if the speed is still too fast;
- (iv) Change down to a lower gear (the 3rd or 2nd gear).

At 'b'

- (i) Depress the accelerator pedal lightly to maintain a steady speed;
- (ii) Do not apply your brakes at this stage;
- (iii) Adjust your path of travel. On a right hand bend, keep close to the left to increase your field of vision. On a left hand bend, keep near to the centre line;
- (iv) Keep your body steady so that you can turn the steering wheel comfortably.

At 'c'

- (i) Look far ahead;
- (ii) If the traffic situation is favourable, accelerate quickly when the front wheels are straightened;
- (iii) Change to the next higher gear.

CHANGING LANES

106 The most difficult aspect of changing lanes is the estimation of speed and distance of vehicles approaching from behind. As such, drivers will have to confirm the situation with regular glances at the mirror inside the cabin as well as the wing mirror. To change lanes safely, this is what you should do:

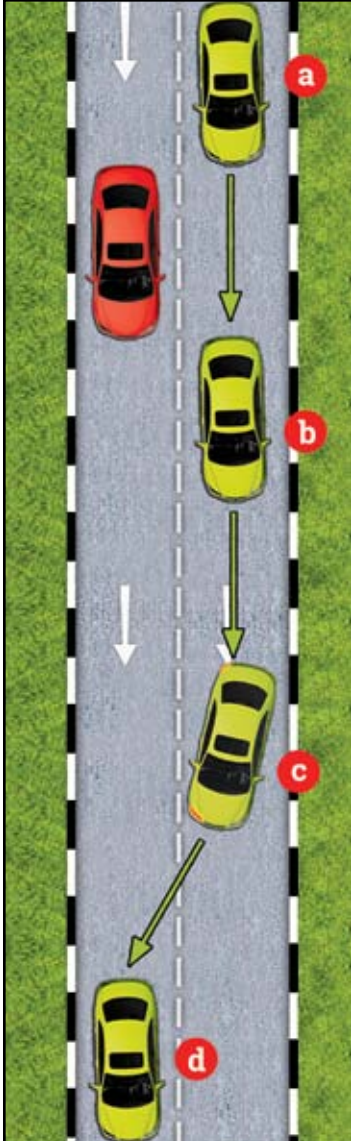

At 'a'

- (i) Check mirrors;
- (ii) Signal your intention;
- (iii) Check blind spots.

At 'b'

- (i) Adjust your speed;
- (ii) You may have to slow down or speed up depending on the traffic situation behind you.

At 'c'

- (i) When it is safe, accelerate smoothly and steer gently into the lane intended without interrupting the flow to traffic.

At 'd'

- (i) Cancel your signal and resume your normal speed.

107 You should not change lanes or cross the centre dividing line unnecessarily.

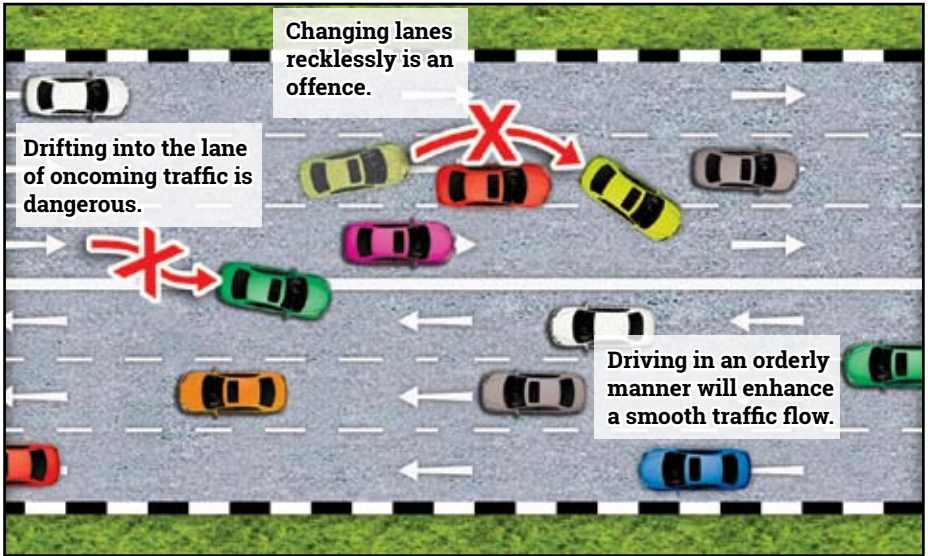

108 Always keep well to the left when driving along two-way streets or dual-carriageways, unless your path of travel is obstructed by road works, parked vehicles, etc. In such circumstance, you may cross the centre line or move to the lane on your right. On doing so, take care to ensure that your intended path is safe and clear before you move to the right.

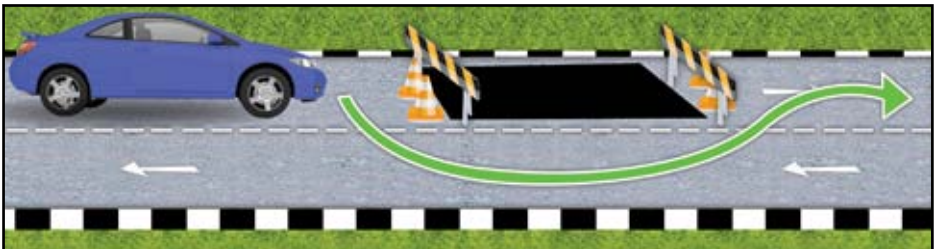

(a) Road Works Ahead.

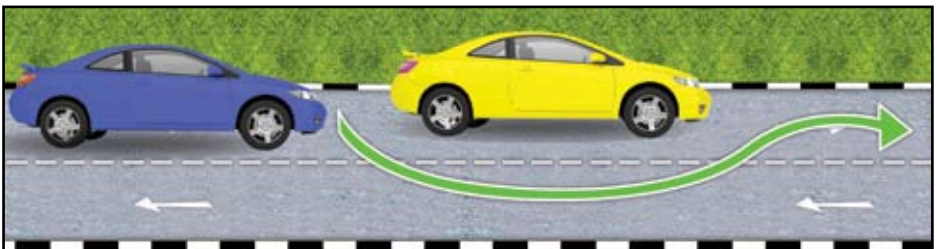

(b) Parked Vehicle Ahead.

BASIC DRIVING TECHNIQUES

109 Where there are two lanes, the left lane is for normal driving and the right lane is for overtaking and turning right.

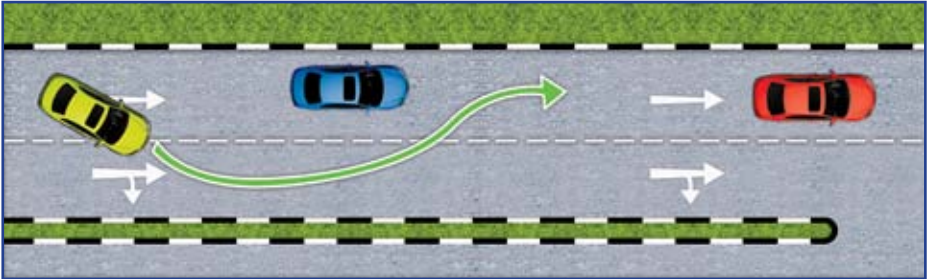

110 Where there are three lanes, the left lane is for slower vehicles, the centre is for faster vehicles and right lane is for vehicles overtaking and turning right.

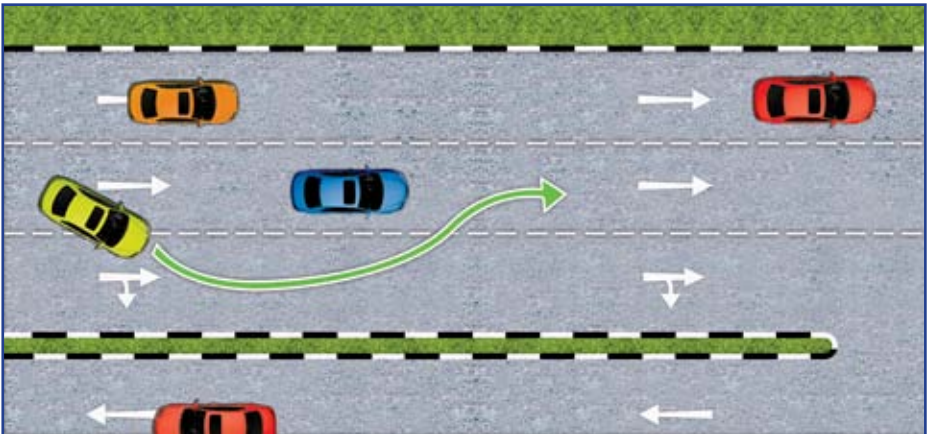

111 Plan your route ahead, choose the appropriate lane and remain in your own lane as far as possible. Do not straddle two lanes simultaneously. If you have missed a turn, do not stop suddenly, reverse or swerve sharply into the desired lane. You should proceed and leave by the next turn.

DRIVING THROUGH JUNCTIONS

112 Many traffic accidents occur at a traffic junctions. It is therefore important for you to analyse situations at junctions quickly and accurately to enable you to select the correct speed and operate your vehicle's controls smoothly. Analysis should be done continuously as the traffic situation is always changing.

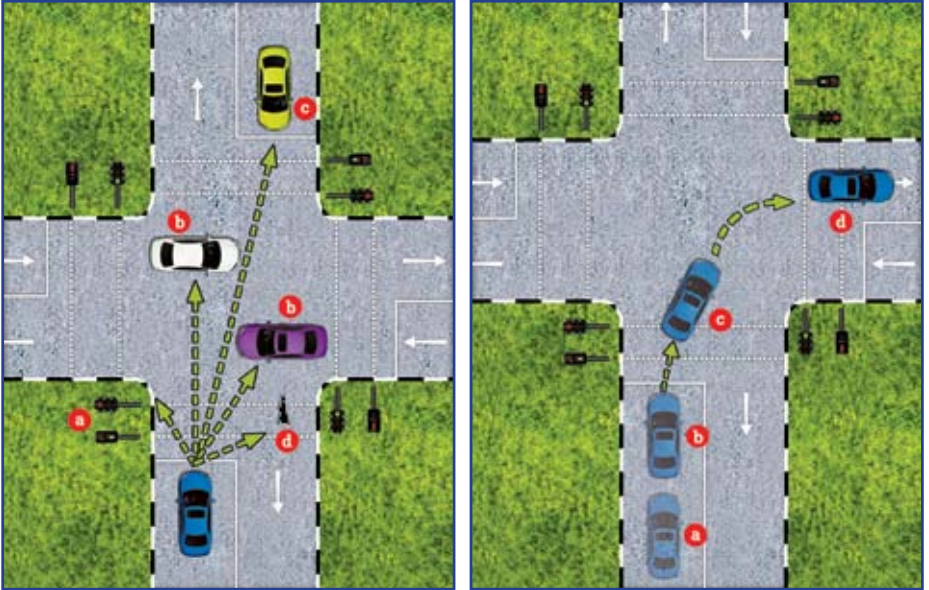

Look out for:

- (a) Traffic lights;
- (b) Vehicles travelling across the road;
- (c) Oncoming vehicles;
- (d) Pedestrians waiting to cross, or crossing the road.

Decide on:

- (a) The position to begin signalling;
- (b) The position to begin lane changing;
- (c) Your final position;
- (d) Your turning path.

BASIC DRIVING TECHNIQUES

113 When passing through a traffic junction adopt the procedure shown below:

(1) TURNING LEFT

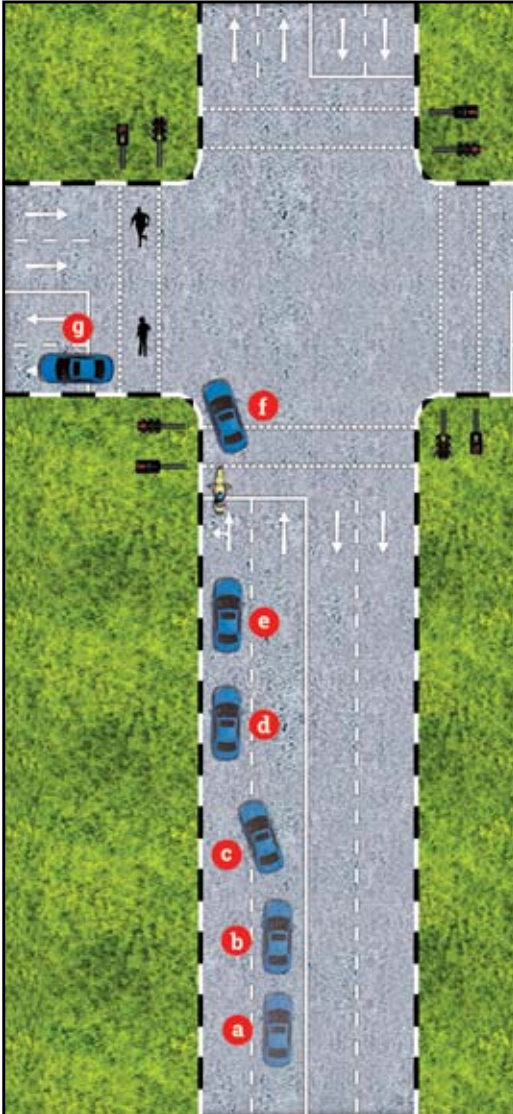

At 'a'

Check your front and rear for vehicles and other road users.

At 'b'

Signal your intention early.

At 'c'

Check your left blind spot and if it is safe, keep left.

At 'd'

Reduce your speed.

At 'e'

Check if the traffic light allows you to proceed. If not, stop behind the stop line.

At 'f'

Look right and ahead to confirm that it is safe to proceed. Keep a look-out for two-wheeled vehicles before you make the turn. Always give way to pedestrians crossing at the junction.

At 'g'

Turn into the nearest lane. After turning left, increase your speed accordingly.

(2) GOING STRAIGHT

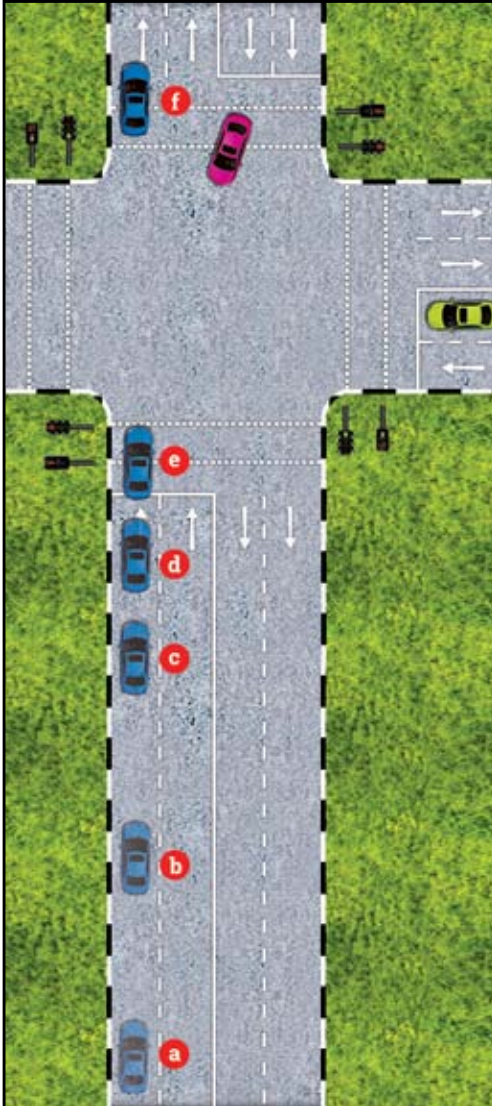

At 'a'

Select the appropriate lane as indicated by the road markings.

At 'b'

Reduce speed as you approach the junction.

At 'c'

Check if the traffic light allows you to proceed. If not, stop behind the stop line.

At 'd'

Check if there are any pedestrians crossing the junction.

At 'e'

Look out for oncoming vehicles which may cross your path.

At 'f'

Increase your speed accordingly.

(3) TURNING RIGHT

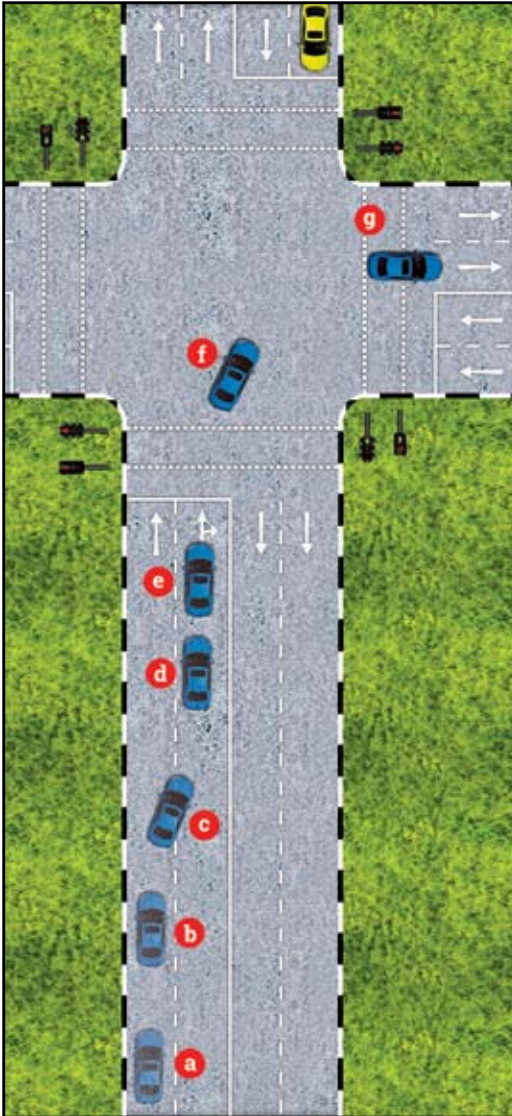

At 'a'

Check your front and rear for vehicles and other road users.

At 'b'

Signal your intention early.

At 'c'

Check your right blind spot and if it is safe, take up the appropriate lane as indicated by the road markings.

At 'd'

Reduce your speed.

At 'e'

Check if the traffic light allows you to proceed. If not, stop behind the stop line.

At 'f'

Drive slowly and cautiously towards the centre of the junction; Give way to oncoming vehicles; Wait until it is safe to cross or wait for the green arrow signal to appear; Turn swiftly to the correct lane keeping a look-out for pedestrians crossing at the junction.

At 'g'

Increase your speed accordingly.

BASIC DRIVING TECHNIQUES

- 114 If you are following behind another vehicle, especially a large vehicle, keep a safe distance. You will not be able to see the traffic lights if you are too close behind a large vehicle.

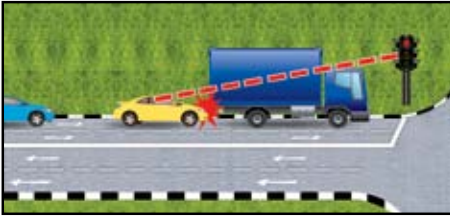

(a) It may result in a rear-end collision. (b) You may 'beat' the red light inadvertently.

- 115 At most junctions, the lanes are individually marked for specific directions. Always obey the lane markings. If you are not in the correct lane for the chosen direction, do not change lane suddenly. Get into the correct lane early.

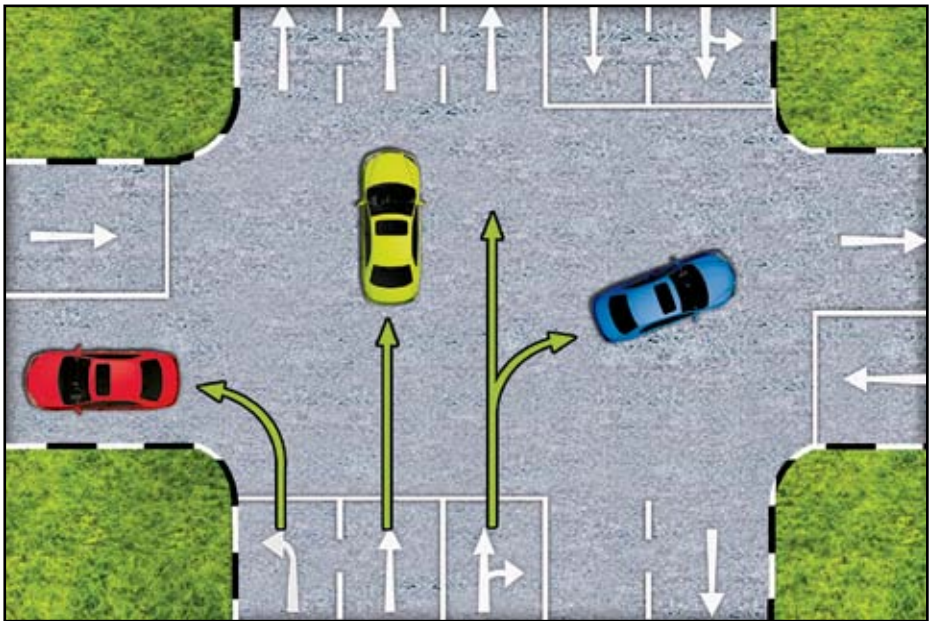

- 116 When turning right into a 'shared' lane for turning right and going straight, signal early so that straight-going vehicles from behind can take an alternate lane to proceed.
- 117 When going straight, avoid using the 'shared' lane so as not to obstruct vehicles turning right when the traffic light changes to 'red' for vehicles going straight.
- 118 Do not accelerate when you are approaching a signalized junction. Always be prepared for the signal light to change by reducing your speed. This will give you time to decelerate evenly when the traffic light changes from green to amber.

119 When the traffic light has just turned amber and you are:

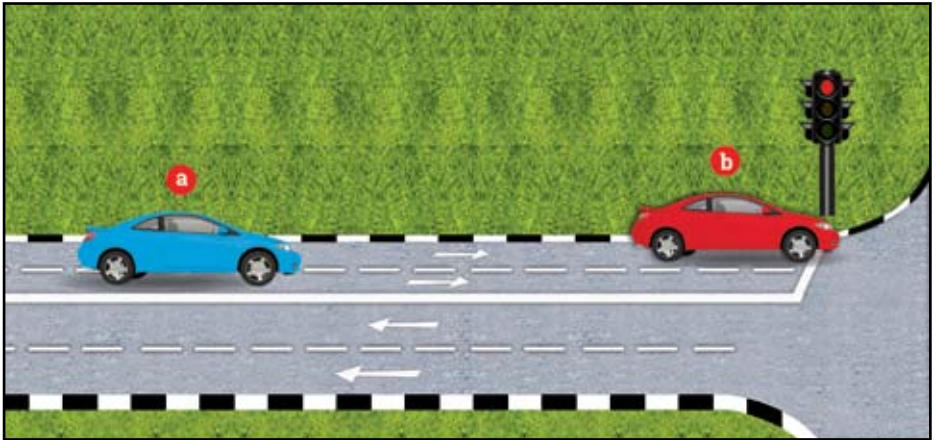

- (a) At 'a' and there is enough distance before the stop line, slow down and stop at the 'stop line';
- (b) At 'b' and you are too near the stop line and you cannot possibly stop safely before the 'stop line', you may proceed.

120 When the road ahead is congested, never proceed even if the traffic light is in your favour regardless of whether it is a yellow-box junction.

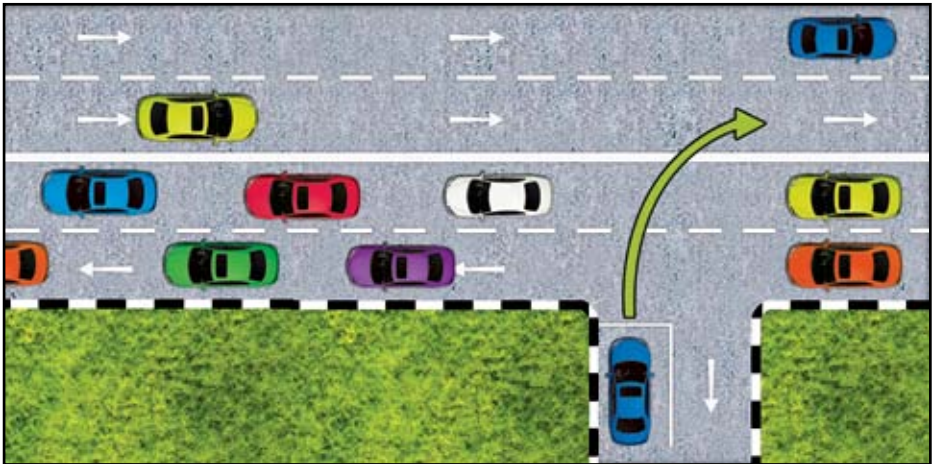

121 In a traffic hold-up, it is courteous to allow vehicles in the minor road to proceed even in the absence of the yellow-box.

BASIC DRIVING TECHNIQUES

- 122 (a) Always stop before the stop line. Do not obstruct pedestrians by stopping over the line.
- (b) When the traffic light facing you turns green, look to the left and right for other vehicles before you start to move off.

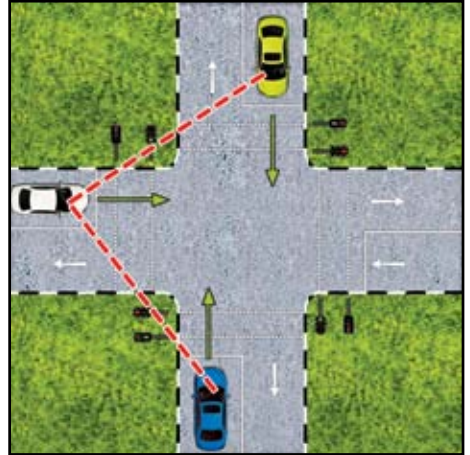
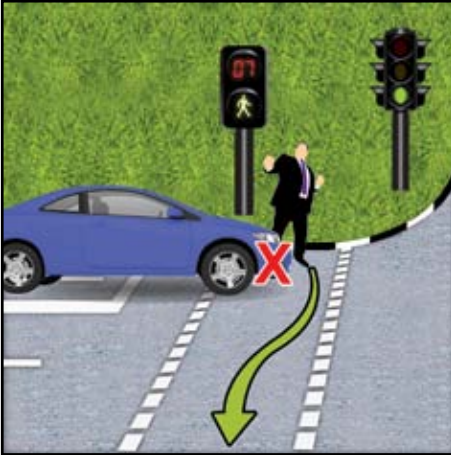

- 123 At a complex junction where many traffic lights are installed, obey the traffic lights facing you.

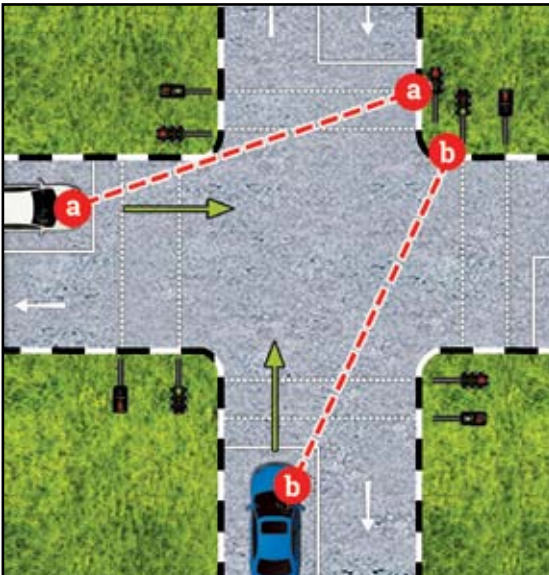

BASIC DRIVING TECHNIQUES

- 124 After you have stopped at the red light, pull up the handbrake in order to prevent any accidental movement.



- 125 When turning left or right at a signalised junction, remember that the pedestrian crossing lights on your left and right may also be green to allow pedestrians to cross the roads to your left and right. Proceed cautiously and if there are pedestrians give way by coming to a complete halt. Proceed only when the pedestrians have cleared your path. Never make a turn in the face of a pedestrian.



BASIC DRIVING TECHNIQUES

126 The traffic lights are out of order when the amber lights flash continuously. If this happens, slow down and look out for the other vehicles. Also look out for the police officer who may be controlling traffic and obey his/her hand signals.

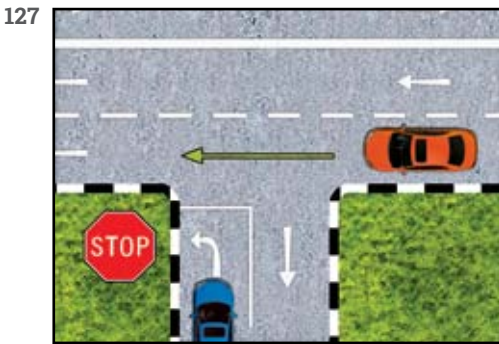
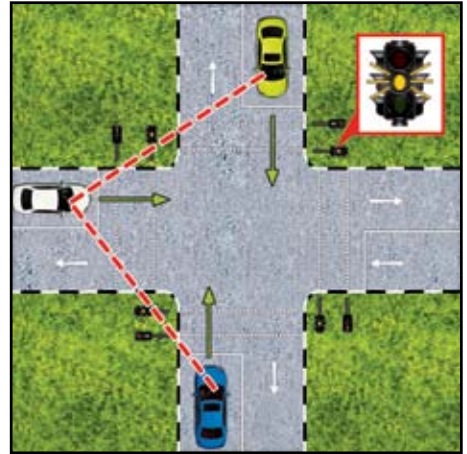

(a) At junctions with a STOP sign, stop behind the stop-line and give way to traffic on the main road.



(b) At junctions with a GIVE WAY sign, slow down or stop if necessary to give way to traffic on the main road.

128 Reduce your speed as you approach a side road. Keep a lookout for other road users, first to the right, then to the left. Get ready to stop if necessary.

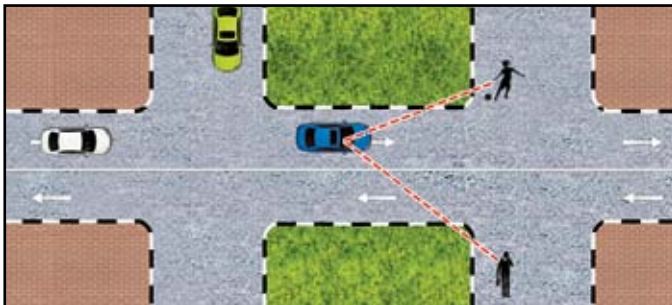

129 If you intend to turn left into a minor road:

- (a) Signal your intention early;
- (b) Keep left and slow down as you approach the junction;
- (c) Never make a wide turn just because the angle is acute;
- (d) Slow down further to complete the turn if the angle is too acute.

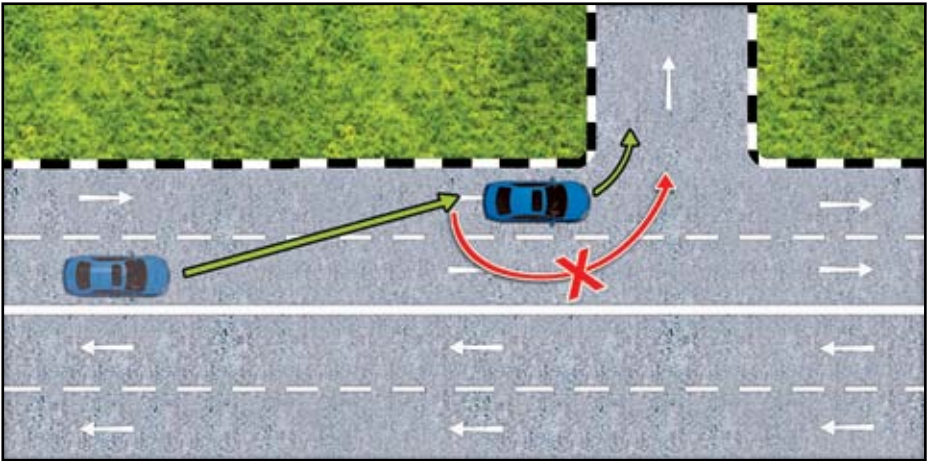

130 If you intend to turn right into a minor road:

- (a) Get into the correct position early;
- (b) Slow down or stop to give way to oncoming vehicles making a turn.

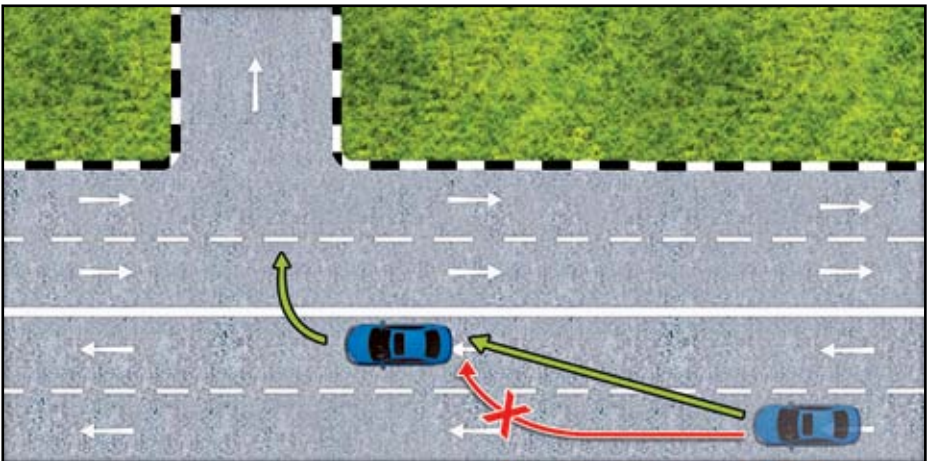

131 At uncontrolled junctions, apply the give way rule:

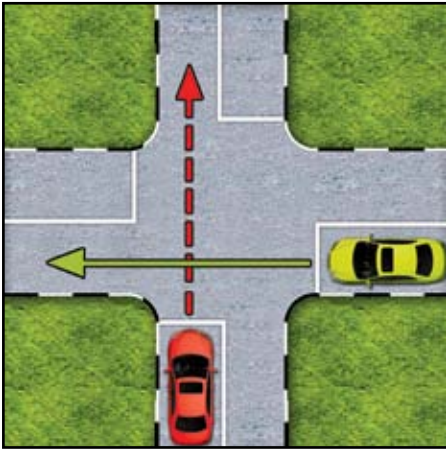

(a) At a cross road, give way to vehicles from the right;

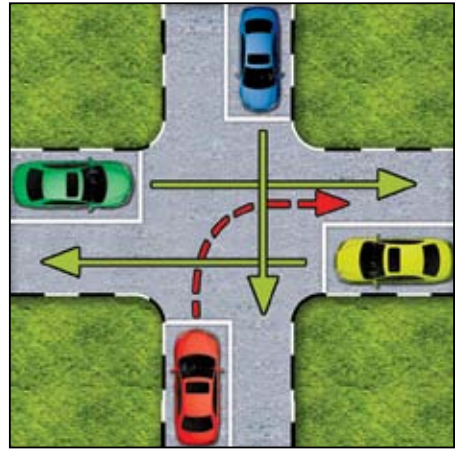

(b) Turning vehicles should give way to going straight vehicles;

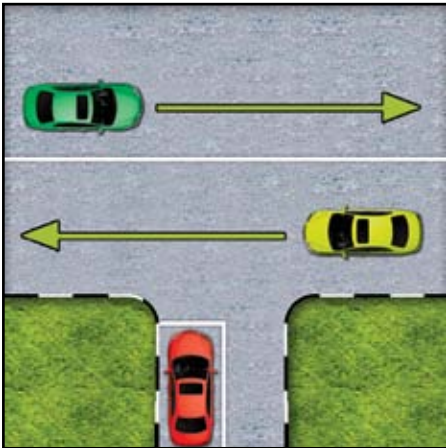

(c) At a T-junction, give way to vehicles on the major road;

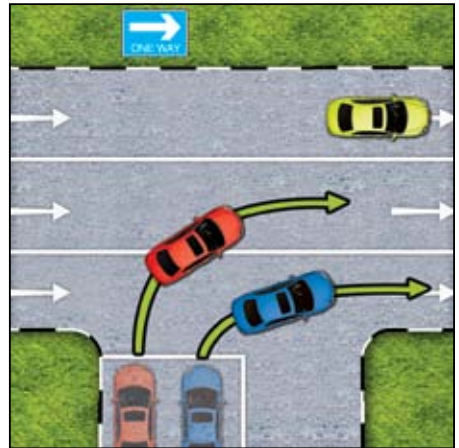

(d) Vehicles turning into a one-way road should adhere to their respective lanes;

BASIC DRIVING TECHNIQUES

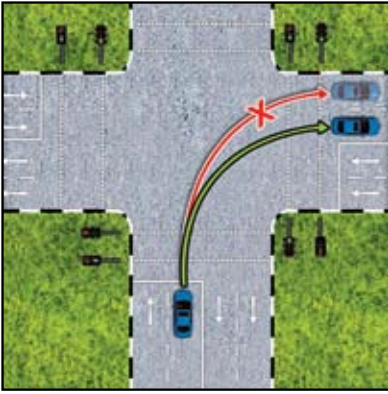

(e) Make an early assessment of your path of travel;

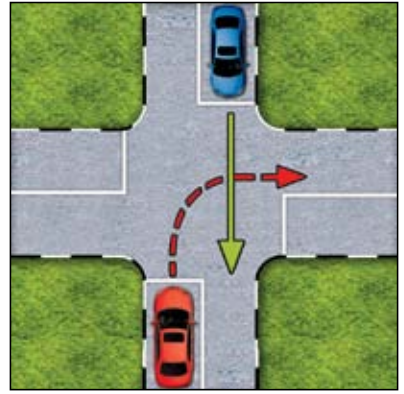

(f) Reduce speed as you approach the turn;

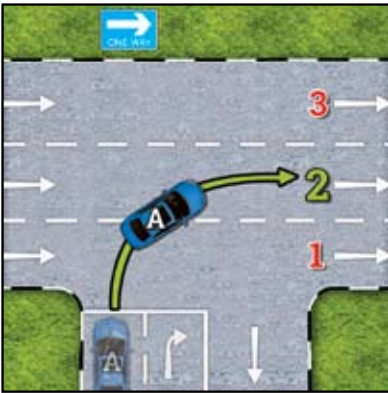

(g) Vehicle A should turn into lane '2';

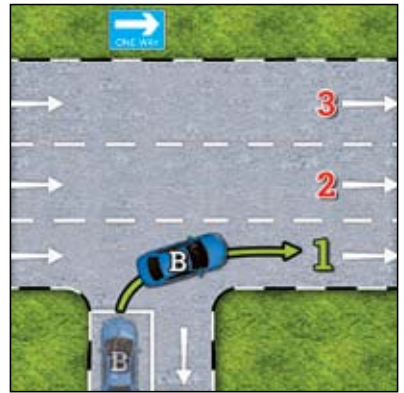

(h) Vehicle B should turn into lane '1';



(i) Vehicle C should turn into lane '2'.

DRIVING THROUGH A ROUNDABOUT

132 When approaching a roundabout:

- (a) Reduce your speed;
- (b) Decide as early as possible which exit you need to take;
- (c) Get into the correct lane;
- (d) Beware of the speed and positions of the traffic around you.

133 When entering a roundabout:

- (a) Give way to traffic on your right in the roundabout (unless road markings indicate otherwise);
- (b) Look out for traffic already in the roundabout;
- (c) Do not enter a roundabout if you can see that your exit is blocked.

134 Once in a roundabout:

- (a) Look out for and give way to vehicles crossing in front of you;
- (b) Be cautious when you are passing an exit or intending to leave by the next exit;
- (c) Signal your intention early when changing lanes;
- (d) Signal left when you are about to leave the roundabout.

135 The general rule is that:

- (a) Traffic from lane A as in the illustration goes to 'A';
- (b) Traffic from lane B goes to 'B';
- (c) Traffic from lane C goes to 'C'.

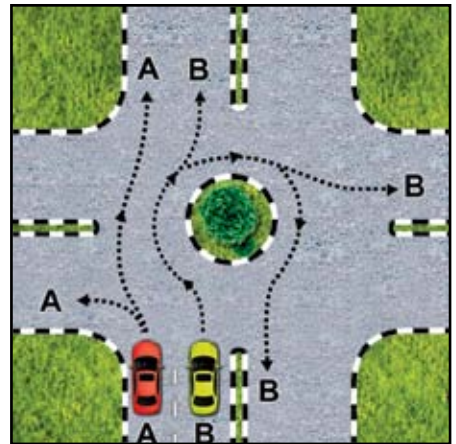
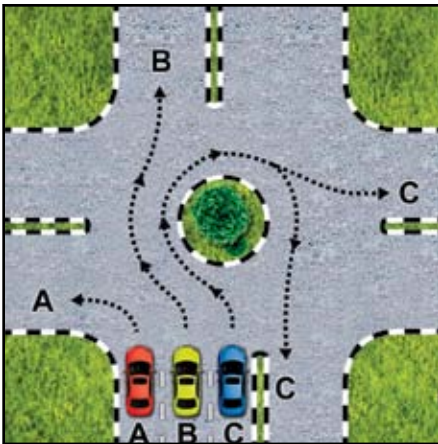

REMEMBER - Traffic coming from your right takes priority over you.

BASIC DRIVING TECHNIQUES

OVERTAKING AND BEING OVERTAKEN

136 Overtaking is unlike changing traffic lanes or simply passing another vehicle. When overtaking, you have to estimate not only the space ahead of you but also the speed and distance of oncoming vehicles. This is a difficult technique and requires good judgement and skill.

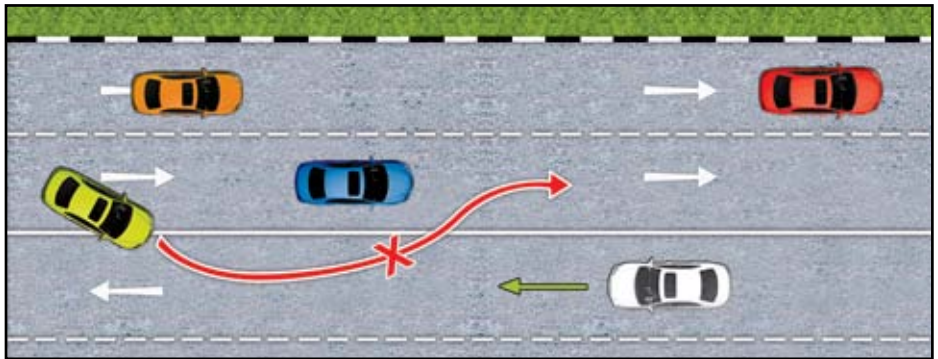
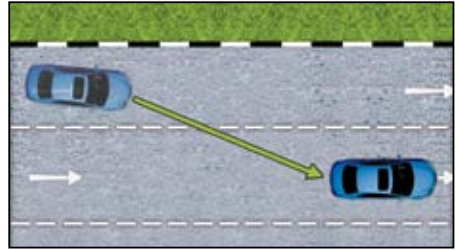
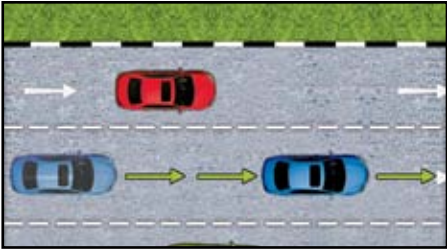

137 Take the following precautions when overtaking:



- (a) Check if there are any traffic signs or road markings which forbid overtaking before you overtake;

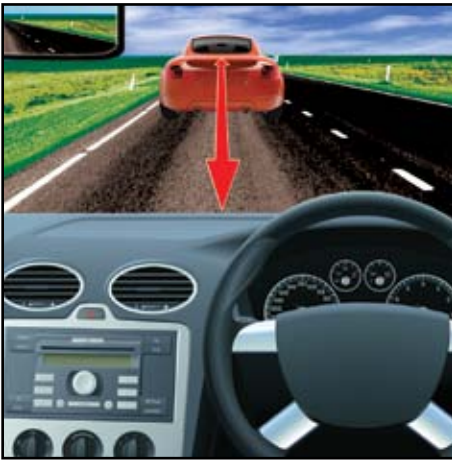

(b) Pay attention to the vehicle in front and the intention of the driver from his/her signals;



(c) Maintain a safe following distance;



(d) Look out for oncoming traffic and ascertain whether you have enough space to get back into your own lane after overtaking;



(e) Check your rear view and wing mirrors to see if there is anyone trying to overtake you;

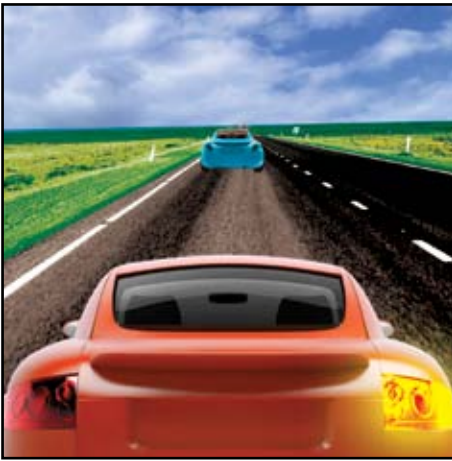

(f) Signal your intention early;

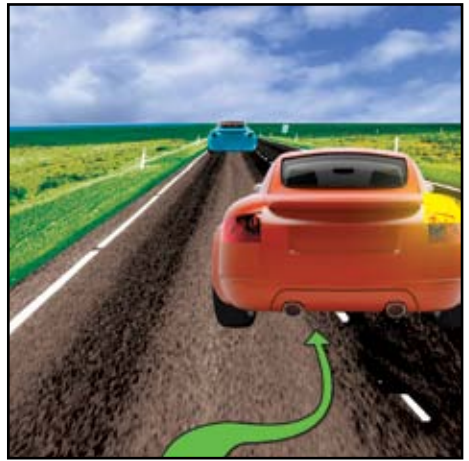

(g) Move over to the right after having checked that your 'blind spot' is clear of traffic;

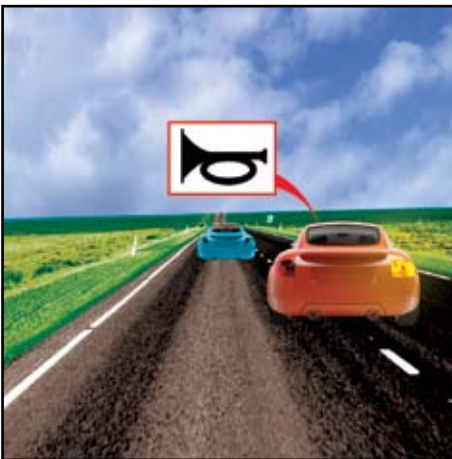

(h) Tap your horn as you are about to pass the vehicle. The driver in front might not have noticed you;



(i) Maintain a safe gap between yourself and the vehicle while you are passing;

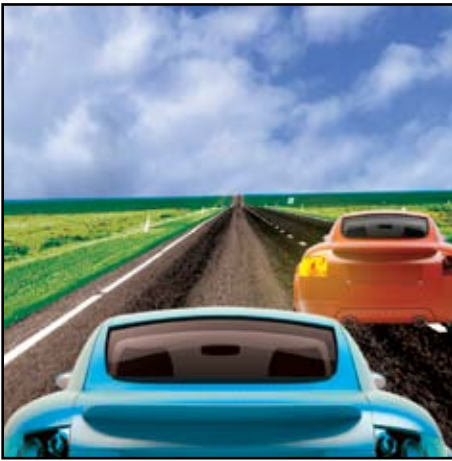

(j) Signal your intention to keep left after overtaking;



(k) When you can spot the vehicle that you have overtaken in your rear view mirror, it is safe for you to keep left.

138 You should not overtake at the following places and situations:

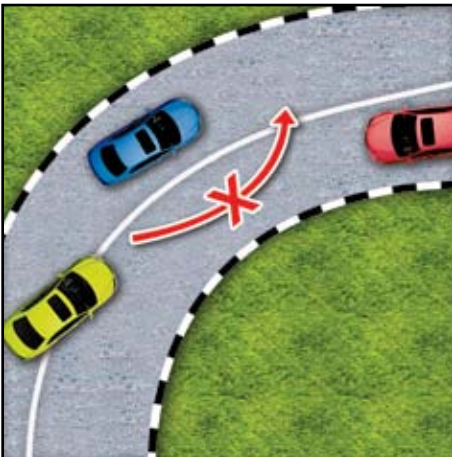

(a) Near or around a sharp bend;

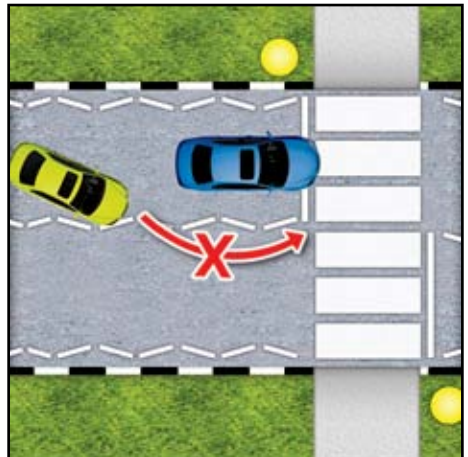

(b) Near a pedestrian crossing;



(c) Near a road junction;



(d) On a narrow bridge;

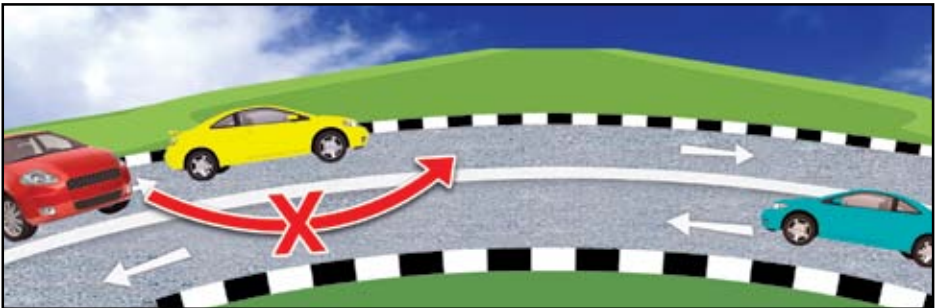

(e) On a steep slope or incline;

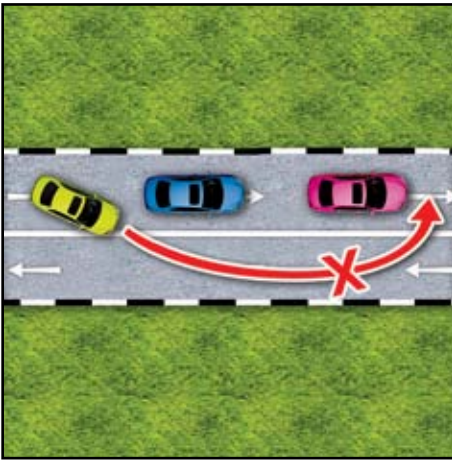

(f) Do not overtake more than one vehicle at a time;

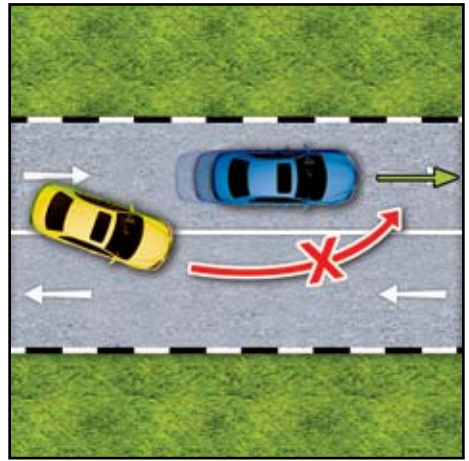

(g) Do not persist in overtaking if the vehicle ahead suddenly increases speed;

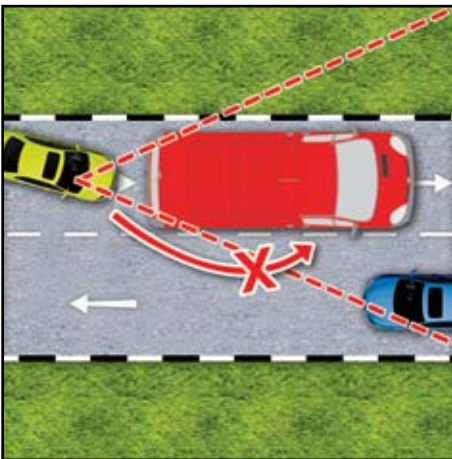

(h) Do not overtake when your front view is restricted or obscured.



139 When being overtaken you should:

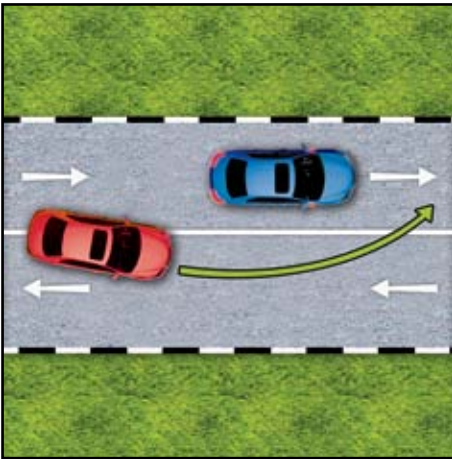

(a) Slow down and make it easy for the overtaking vehicle;

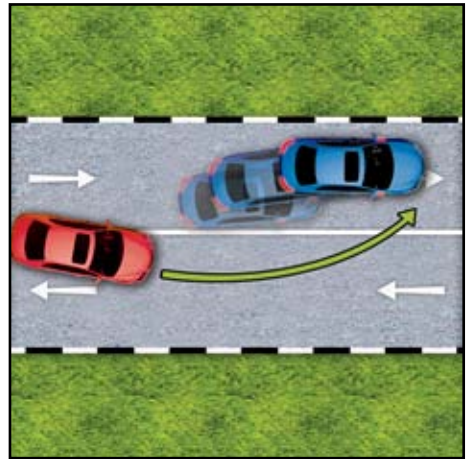

(b) Keep close to the side, if necessary;

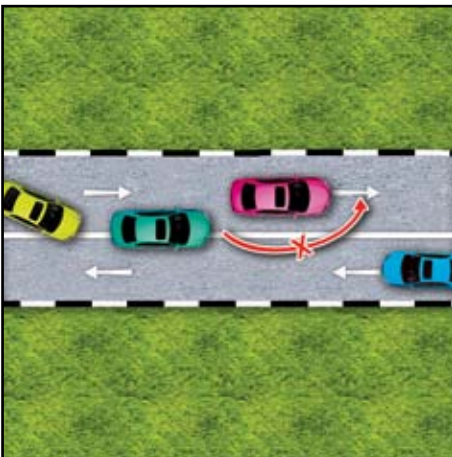

(c) Do not try to overtake others when you are being overtaken;

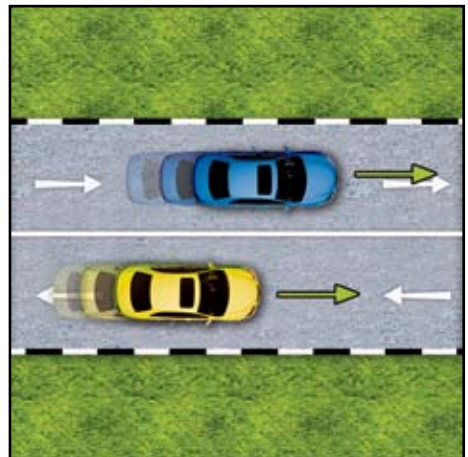

(d) Do not race with the passing vehicle.

BASIC DRIVING TECHNIQUES

STOPPING AND MOVING OFF ON SLOPES

- 140** The technique of stopping a vehicle on a slope or incline is almost the same as that of stopping on a level road. The only difference is that you apply less pressure on the brake pedal to stop the vehicle on a level road than on a slope. The handbrake must also be applied before the brake pedal is released.
- 141** Moving off on a slope involves co-ordinating the clutch, the accelerator and handbrake. It is therefore important that you master the 'half-clutch' technique. Do not maintain the half-clutch position for too long as the heat caused by the slipping of the clutch will wear the clutch lining rapidly.



- 142** Follow the sequence below when moving off on a slope:

- Engage the 1st gear;
- Put your hand on the handbrake;
- Depress the accelerator pedal;
- Use the 'half-clutch' technique, noting the slight reduction in engine noise at the point of engagement. You can also feel the vehicle wanting to move forward. This is known as the 'biting-point';



BASIC DRIVING TECHNIQUES

- (e) Look into the rear and side mirrors to check if it is safe;
- (f) Release the handbrake while still maintaining the half-clutch position;
- (g) Depress the accelerator pedal further and release the clutch pedal gradually.

The vehicle will start to move.



143 Should the engine stall while moving off an incline:

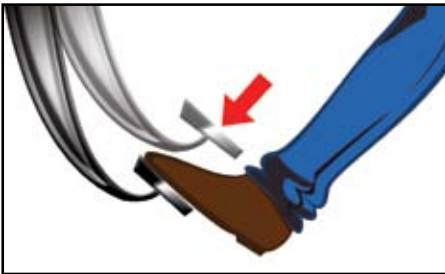

(a) Step on the brake pedal immediately to prevent the vehicle from rolling backwards;



(b) Pull up the handbrake;



(c) Shift the gear to the Neutral position;



(d) Depress the accelerator pedal slightly and re-start the engine.

REVERSING

144 Reversing is a more difficult technique than forward driving. You need a lot of practice to be good at it. Begin by reversing in a straight line. This is to identify mistracking early and enable appropriate adjustment. When you are able to drive backwards in a straight line well, set other courses (with poles etc.) and practice until you are familiar with the relationship between the steering and the path which the vehicle takes.

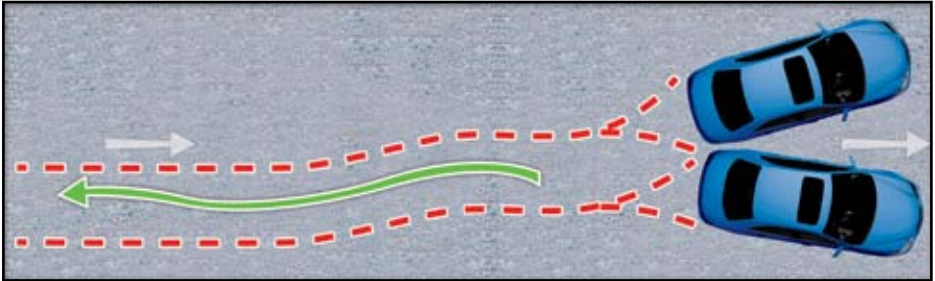

145 An effective way to improve correct steering while reversing is to reverse from a slanted position and get your car straightened in as short a distance as possible.

146 When reversing a vehicle round a corner:

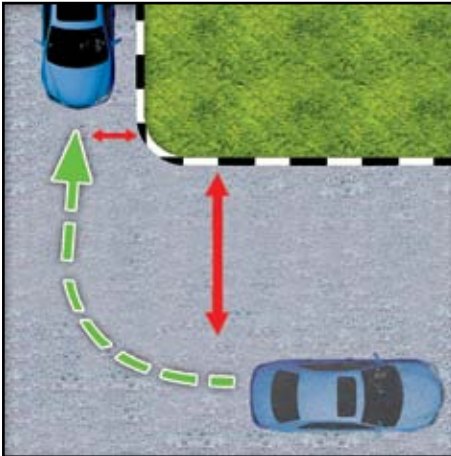

(a) the resulting gap between the vehicle and the kerb is narrow if the initial gap is wide;

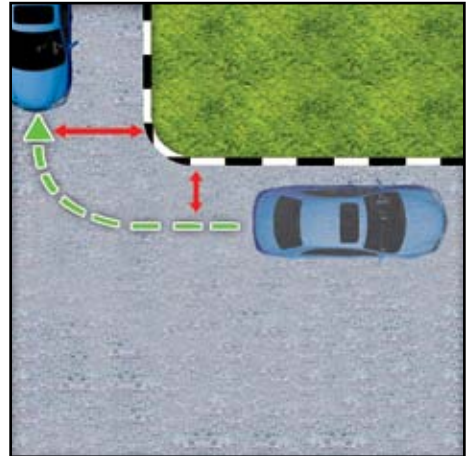

(b) the resulting gap will be wide if the initial gap is narrow.

BASIC DRIVING TECHNIQUES

147 In view of the difficulty in seeing and controlling the steering wheel, reversing should always be carried out at a very slow speed. To achieve this, you have to control the clutch pedal by releasing and depressing it repeatedly so that the engine power is not continuously transmitted to the driver-wheels. This should be done with the accelerator pedal slightly depressed.

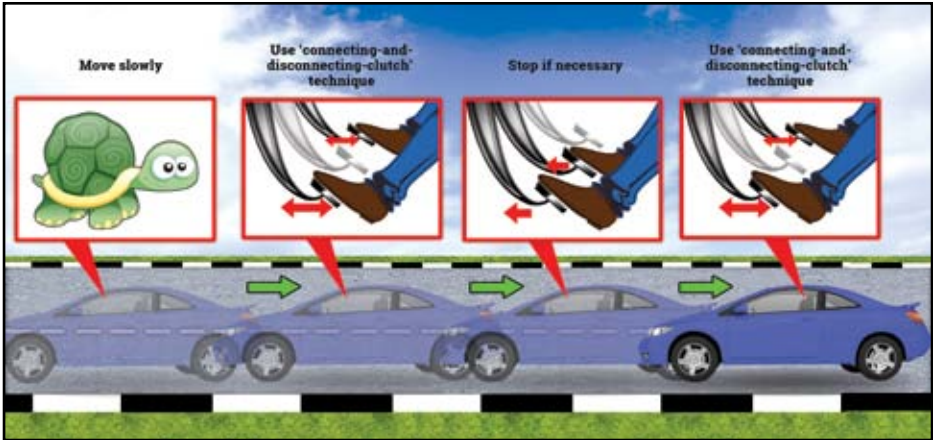

148 You should not sit in a forward-driving posture and rely on your rear view mirror while reversing. Instead, you should turn your body to your left and at the same time turn your head to look through the rear windscreen.

149 To reverse a vehicle into a limited opening requires a good sense of judgement of the position of all the wheels of the vehicle.



(a) View towards the front.



(b) View towards the rear.

Try to visualise the position of all four wheels from the driver's seat.

VERTICAL PARKING

150 To reverse into a vertical parking lot, take the following steps:



- (a) Before pulling over for the reversing manoeuvre,
- (i) Check the rear view mirror;
 - (ii) Signal your intention;
 - (iii) Check your left blind spot;
 - (iv) Position your vehicle about half a vehicle length ahead of the vertical parking lot and about 1.5 metres away from the kerb;
 - (v) After observing that your rear is clear, reverse slowly while looking through the rear windscreen and the side mirrors.
- (b) When the corner of the kerb/lot is sighted in line with the rear left tyre at the left side mirror, check the right hand side for any passing vehicle and turn the steering wheel 'full lock' to the left at the same time. Reverse slowly and check left and right side mirrors to confirm safe clearance between vehicle and kerb, make adjustments if necessary. Look through the rear windscreen while reversing;



(c) When the vehicle is about parallel to the kerb, return the steering wheel to its straight-ahead position and continue to reverse in a straight line;

(d) Stop your vehicle before it touches the kerb at the rear.

151 When reversing into a parking lot between other parked vehicles, use the same technique as mentioned above. In this case you should use the right corner of car A as a guide. As the right corner of car A is sighted in your left quarter-glass, turn your steering wheel 'full lock' to the left.

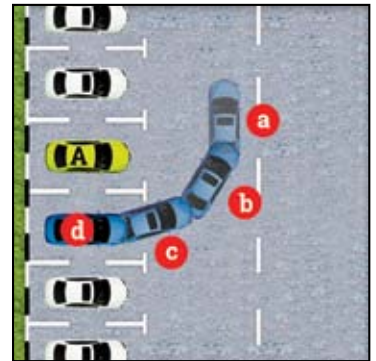

152 Before moving out of the lot, check for traffic on both sides of the road. When it is safe, drive forward slowly until your body is in line with the front bumper of the vehicle on your left. Turn the steering wheel 'full lock' to the left and drive out carefully. Do not make a wide turn when moving out.

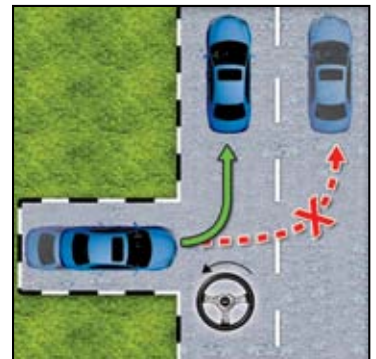

DIRECTIONAL CHANGE

153 The directional change is a driving technique used to bring the vehicle to face the opposite direction, and involves the following steps:



- (a) (i) Look around and estimate the appropriate position to stop at;
- (ii) Position your vehicle approximately in the centre of the lane;
- (iii) Your vehicle should be as far forward as possible.

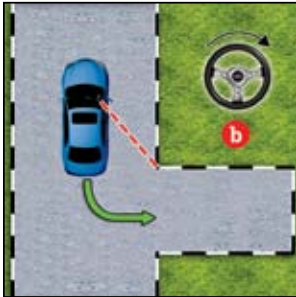

- (b) (i) After checking that it is safe, reverse slowly using the 'connecting-and-disconnecting-clutch' technique;
- (ii) Look over your right shoulder; when you can see the corner of the kerb through the right rear window, turn the steering wheel 'full lock' to the right and check the front left side of the vehicle to ensure that there is sufficient turning space.

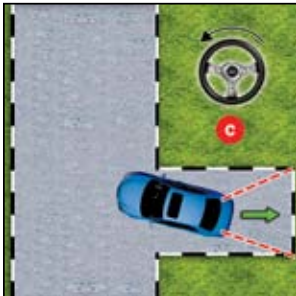

- (c) (i) When your vehicle is almost parallel to the kerb, return the steering wheel to its straight-ahead position;
- (ii) Look through the rear wind-screen and continue to reverse in a straight line;
- (iii) Stop your vehicle just before touching the kerb at the rear.



- (d) (i) To complete the manoeuvre, drive forward until the steering wheel is in line with the kerb, then turn it 'full lock' to the left and move slowly out of the opening;
- (ii) When your vehicle is almost parallel to the kerb, return the steering wheel to its straight-ahead position to resume a straight course.

PARALLEL PARKING

154 To park in a parallel parking lot, follow the steps below:



- (a) Perform the safety checks before beginning the manoeuvre; Position your vehicle a short distance ahead of the parking lot and leave a gap of 0.5 to 1 metre from the kerb. Your vehicle should be parallel to the kerb. After observing that the rear is clear, look through the rear windscreen and reverse slowly;

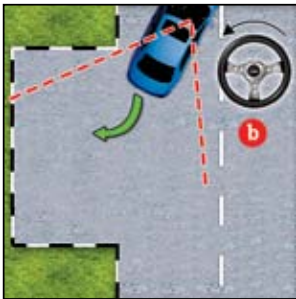

- (b) When the back bumper is about 0.5 metres past the corner of the kerb/ lot, turn the steering wheel 'full lock' to the left and at the same time check the right hand side for any passing vehicle and other road users, including cyclists and pedestrians. Continue to reverse slowly;



- (c) When your vehicle is at an angle of 45 degrees to the kerb, (or your left side mirror is aimed at the half-way point along the kerb of the parking lot), return the steering wheel to the straight-ahead position and continue to reverse in a straight line;

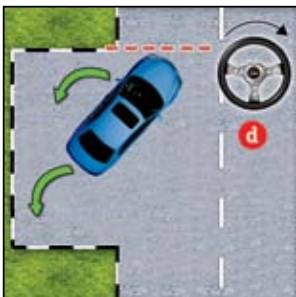

- (d) When your vehicle is half-way in the lot and the front bumper is in line with the corner of the kerb/lot, turn the steering wheel 'full lock' to the right to bring the vehicle further into the lot;



- (e) Reverse slowly while looking through the rear windscreen. When your vehicle is almost parallel to the kerb, quickly turn the steering wheel to the left. Stop your vehicle before it touches the rear kerb;



- (f) Turning the steering wheel back to the straight ahead position while driving forward. Stop your vehicle in the centre of the lot.

155 Before moving off, check that it is safe to do so:



- (a) Drive forward slowly and turn the steering wheel to the right; As you are about to stop (i.e. just before touching the front kerb), quickly turn the steering wheel to the left in preparation for the next move;



- (b) Reverse slowly and turn the steering wheel further to the left to 'full lock'. Just as your vehicle is about to touch the rear kerb, quickly turn the steering wheel to the right in preparation for the next move;



- (c) Confirm that it is safe to move out. Drive forward slowly and turn the steering wheel further to the right;



- (d) As the front bumper clears the front kerb, return the steering wheel to the straight ahead position, keeping a gap of 1 metre from the kerb as you drive out of the lot. Do not make too wide a turn when moving out.

156 Parallel parking along the road side between other parked vehicles is done in the same manner as described above. Imagine the position of the back bumper of the vehicle (X) as that of the corner of the front kerb and the position of the front bumper of vehicle (Y) as a guide.

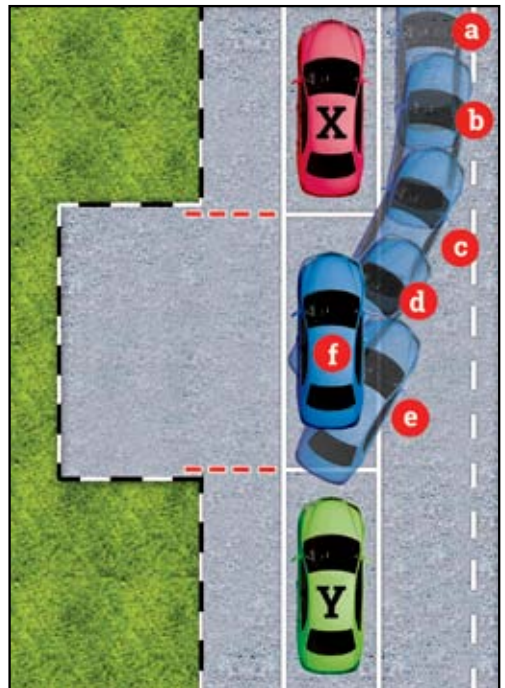

BASIC DRIVING TECHNIQUES

EMERGENCY STOP

- 157 When in an emergency, you need to react quickly to stop the vehicle in the shortest possible distance without losing control of the vehicle. Remember, the vehicle will not stop instantly when you hit the brakes.
- 158 From the time you realise the need to **react** until the time the vehicle comes to a complete **stop**, the vehicle would have travelled a considerable distance. **Reaction distance** is the distance from when a hazard is identified to the point at which the brake is applied.
- 159 The **stopping distance** of a vehicle comprises the **reaction distance** and the **braking distance**.

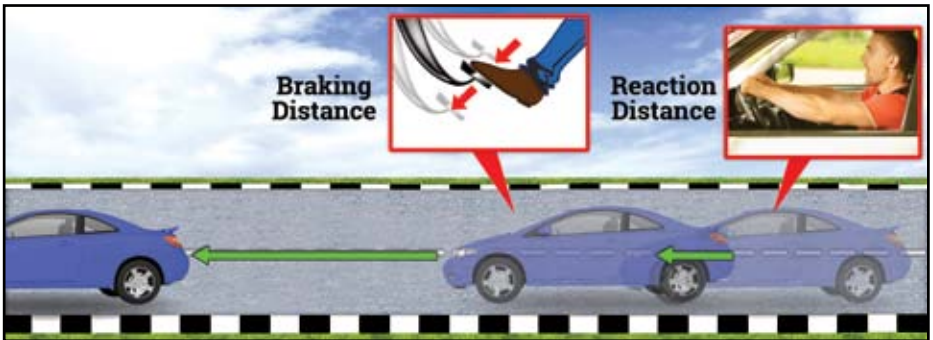

The approximate stopping distance for the speeds are indicated below:

$$\text{Reaction Distance} + \text{Braking Distance} = \text{Stopping Distance}$$

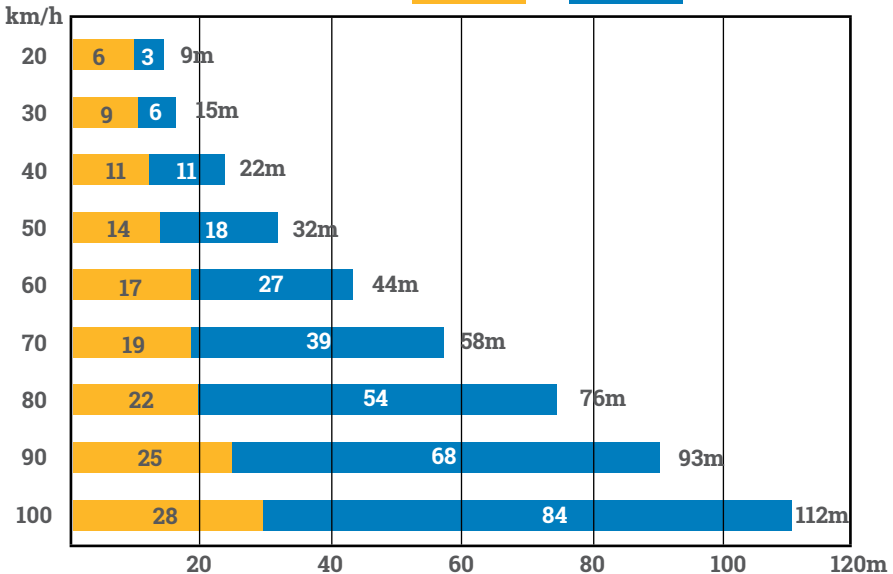

BASIC DRIVING TECHNIQUES

160 When applying the emergency brake, you should:

- (a) keep both hands firmly on the steering wheel in a straight course. This is because you need the greatest possible control over the steering at this crucial moment;
- (b) avoid braking too hard so as to prevent the wheels from locking. Locking of the wheels may cause the vehicle to skid;
- (c) always depress the brake pedal first followed by the clutch pedal when the vehicle is close to a complete stop.

NARROW COURSES

161 When a vehicle turns left, the rear left-wheel will take a path closer to the kerb than the front left-wheel. Likewise, when it turns right, the rear right-wheel will go closer to the kerb than the front right-wheel. You will therefore have to be careful of the rear sides of your vehicle when passing through a narrow course.

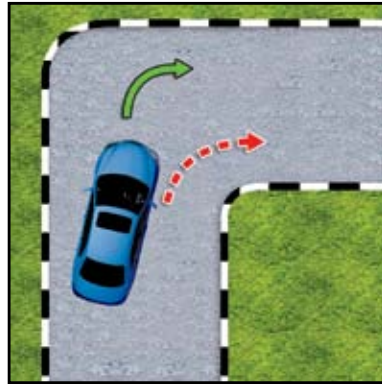
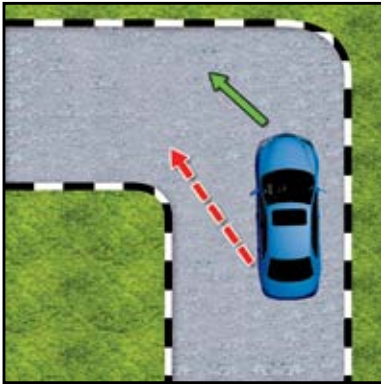

162 Since the rear wheels always take a path closer to the kerb, it is necessary to adjust your vehicle's position before turning into the bend to prevent your vehicle from hitting or mounting the kerb.

(a) **Left Bend** - Position your vehicle more to the right.

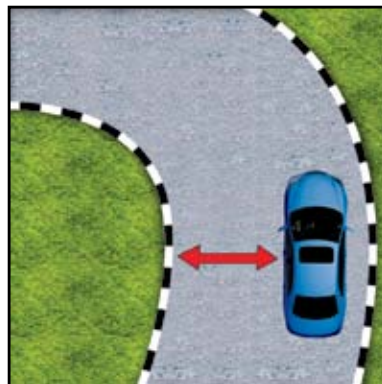
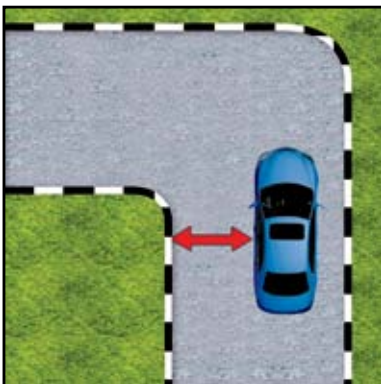

(b) **Right Bend** - Position your vehicle more to the left.

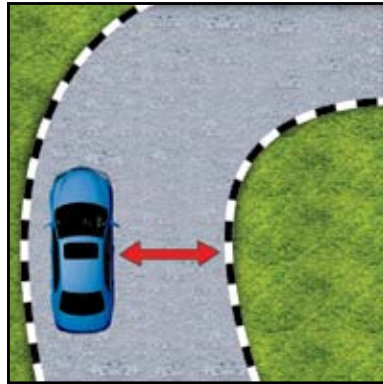
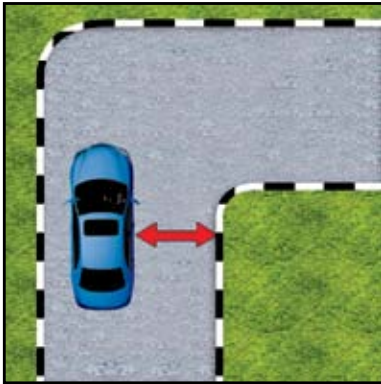

163 When negotiating a sharp bend, the body of the vehicle will always appear to protrude well outside the course when viewed from the driver's seat.

So long as you know the position of the front wheels of the vehicle and can visualise the path to be taken, your vehicle will stay on course.



164 In a narrow course, if you turn too early or too late into a bend, you may not be able to execute the turn smoothly.

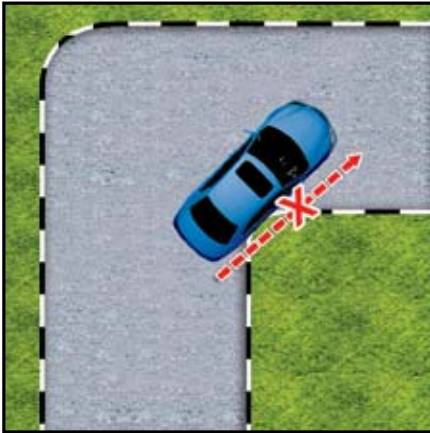

(a) The rear wheel is obstructed when you turn too early.



(b) The front wheel is obstructed when you turn too late.

165 To correct this mistake, reverse your vehicle to its original position and repeat the turn.

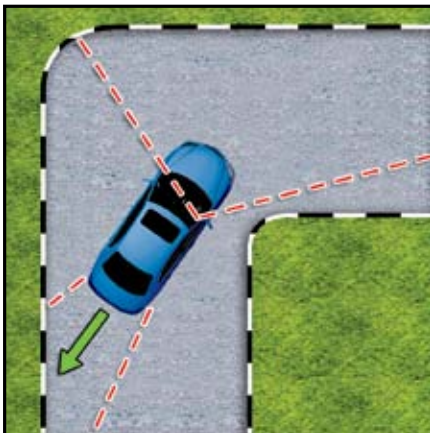

(a) When reversing, look through the rear windscreen to have a complete rear view. Keep the contour of the road in your mind.

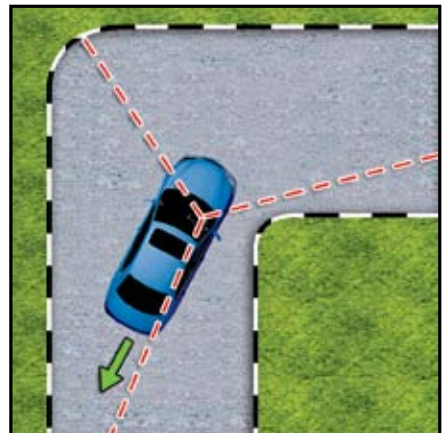

(b) As you reverse, glance periodically to the front to see if you have enough space to move forward.

BASIC DRIVING TECHNIQUES

166 Keep your speed low by shifting down to the 2nd or the 1st gear and by using the 'connecting-and disconnecting clutch' technique to maintain a low speed.

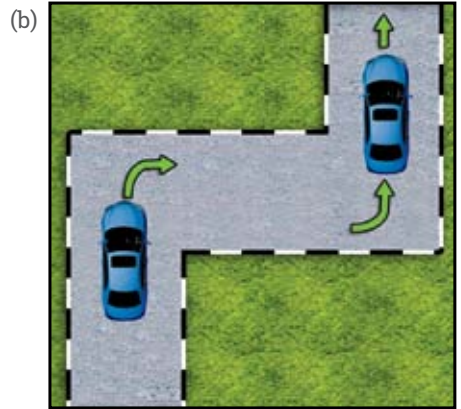
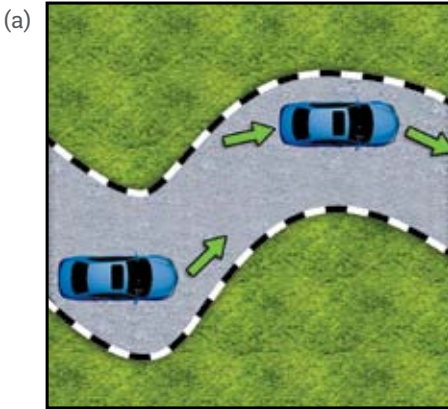

167 Before passing through a narrow course, take a good look at the entire course. Visualise the path of travel of your vehicle.

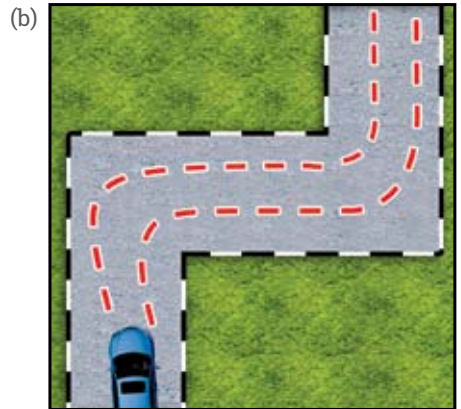
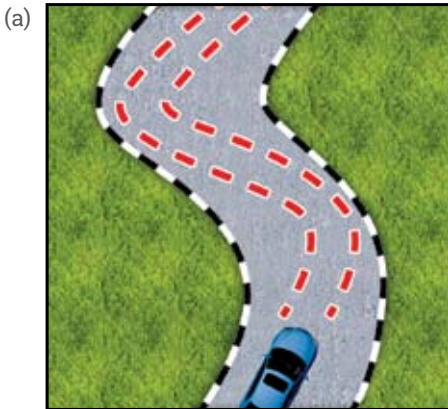

SAFE DRIVING TECHNIQUE (DEFENSIVE DRIVING TECHNIQUE)

168 Safe/Defensive driving technique:

Driving safely and competently demands the total involvement of most of your senses. It is not enough to gain physical mastery of the vehicle without cultivating an awareness of the environment. A good driver can interpret, anticipate and act unhesitatingly under adverse driving conditions.

169 Adverse conditions include:

- (a) Driver conditions
- (b) Weather conditions
- (c) Light conditions
- (d) Road conditions
- (e) Traffic conditions

170 DRIVER CONDITIONS

Your physical and mental condition can affect your driving. These conditions are:

- (a) Your vision,
- (b) Your physical health,
- (c) Your mental state,
- (d) Consumption of alcohol and drugs.

171 Eighty percent (80%) of information perceived while driving comes through the driver's eyes. It is therefore important that you make optimal use of your eyes when driving. Do not fix your eyes on a particular object for longer than necessary. Keep moving your eyes about every two seconds or so. Also, take regular glances at the rear view mirrors every five to ten seconds so that you are aware of the changing situation around you.

172 Tiredness, giddiness and being unwell can effect your concentration on the road. If you feel unwell or tired, do not drive.

173 Anger, worry and stress can also reduce concentration and may lead to rash or careless driving on the road.

174 Consumption of alcohol and certain types of drugs affect your judgement, concentration and reaction time. If you are on medication, check with your doctor whether the prescribed medicine you are taking will affect your driving ability. If so, do not drive. It is also unsafe for you to drive if you have consumed alcohol.

175 It is an offence for a person to drive or attempt to drive a vehicle while under the influence of alcohol. If a driver is suspected to be under the influence of alcohol, he/she will be required to undergo a breath analyser test. A person with a BAC (Blood Alcohol Concentration) exceeding 80mg per 100ml of blood is presumed incapable of controlling his/her vehicle properly.

176 WEATHER CONDITIONS

Adverse weather conditions affect your ability to see and be seen. These conditions are:-



RAIN



FLOOD



STRONG WINDS

177 The basic rules to follow when driving in bad weather conditions are:

- Reduce your speed so that you can manoeuvre safely.
- Do not out-drive the actual distance that you can see clearly.
- Switch on your headlights so that you can see more clearly and be more visible.
- Turn on the demister to clear the mist on the windscreen.
- Move to a safe spot and stop at the side of the road with your hazard lights turned on if you cannot see clearly. Proceed when conditions are favourable.
- Use a faster front windscreen wiper speed when driving in heavy rain.

178 On a wet road, the stopping distance of a vehicle will increase to about twice the distance of that on a dry road. This is because there is less friction between the tyres and the wet road surface. On a wet road, stepping hard on the brake pedal (locking the wheels) will cause the vehicle to skid or spin. If you lock the wheels accidentally, quickly release the brake pedal and apply the intermittent (ON/OFF) braking technique until the vehicle comes to a stop. Thus, on a wet road, it is important that you drive at a slower speed to avoid such dangerous circumstances.



DRIVING IN TRAFFIC

Safe Driving Technique
(Defensive Driving Technique)

179 On a rainy day, a thin layer of water forms on the road surface. Even good tyres may not have a good grip on the road. As speed increases, surface water builds up under the vehicle's tyres. When this happens, your vehicle will glide on the surface of the road, and this is known as 'Aquaplaning'.



180 Aquaplaning results in the loss of steering control and braking efficiency. The faster you go, the more difficult it will be to control the vehicle. To counter this, you should slow down by braking intermittently (on/off braking) until you gain control of your vehicle.

181 When approaching a road that is flooded but passable to vehicles, engage a lower gear to go through the flood.

182 After passing through water, the brakes become ineffective. To dry the brakes, pump the brake pedal repeatedly until braking action returns.



183 You can also dry the brakes by gently depressing the brake pedal with your left foot while pressing the accelerator with the right foot.



184 At night, the depth of flood water can be deceptive. If in doubt, take an alternative route.

185 Stretches of open highways are usually subjected to strong winds. To avoid the danger of being forced into the path of other traffic by the wind, you should slow down and drive cautiously.

186 LIGHT CONDITIONS

Too much or too little light will affect our ability to see. Sun-glare or light reflected off objects or a pool of water on the road can dazzle and even blind our vision. You should wear sunglasses or lower the sun-visor when it is very bright.



DRIVING IN TRAFFIC

Safe Driving Technique
(Defensive Driving Technique)

- 187 Switch on your headlights from 7pm to 7am. Drive at a slower speed than you would during the day.



- 188 When the headlight of an oncoming vehicle dazzles you, look to your left to avoid the glare. Use the edge of the road to guide your vehicle. If the light is blinding, slow down and stop by the side of the road.



- 189 When facing oncoming traffic, dip your headlights.

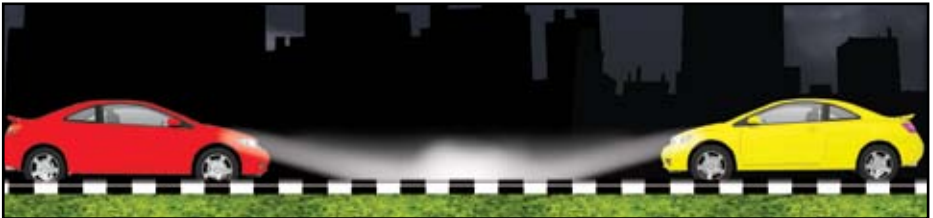

- 190 Dip your headlight when you are immediately behind another vehicle. If not, the beam from your headlight will be reflected by the rear view mirror of the car in front and dazzle the driver.



191 On approaching bends where visibility is poor, use your high beam. This will attract the attention of other road users and warn them of your approach.

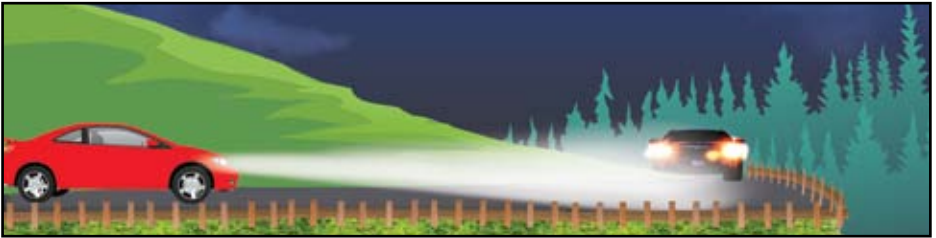

192 It is safer not to out-drive your normal headlight range. The average headlight on high-beam is about 100 metres.



193 ROAD CONDITIONS

A good driver should know how to read and adjust his/her speed accordingly to suit the road conditions, such as:

- (a) The width of the road;
- (b) The kind of road surface he/she is driving on;
- (c) The contour of the road;
- (d) The possible danger of hazards ahead.

194 On a sandy or pebbled surface, there is a greater risk of 'side slipping'. Try to avoid hard acceleration, braking and sudden sharp turning of the steering wheel.



195 If the rear of your vehicle skids side way, remove the foot from the accelerator at once. Never apply the brakes during a skid correction, steer in the direction of the skid.



DRIVING IN TRAFFIC

Safe Driving Technique
(Defensive Driving Technique)



(a) On roads with uneven surfaces, drive slowly.



(b) If you encounter large pot-holes, reduce your speed further and proceed slowly.

196 When driving round a bend or sharp corner at high speed, your vehicle tends to be pushed out of its path of travel by a force called the Centrifugal Force.



197 The greater the travelling speed around the curve or the sharper the curve, the more the vehicle will be pushed from its path. You should therefore reduce speed when going round a bend. The diagram on the right shows the appropriate speed and the dangerous speed for each turning radius.

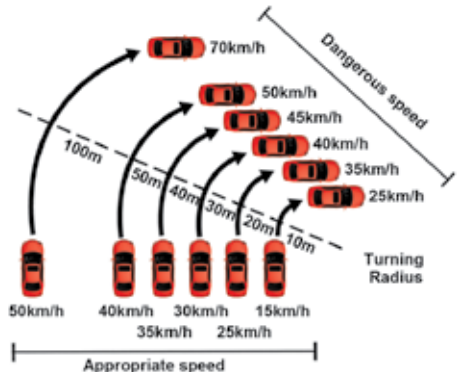

198 TRAFFIC CONDITIONS

Traffic conditions vary depending on time, place and situation. Traffic may be congested or relatively light. The speed of other vehicles also varies. Try to drive with the traffic in order not to disrupt its flow.

199 Adjust your speed to the traffic and road situation. Situations change as you travel from urban built-up areas to sub-urban and then to rural areas.



URBAN



SUB-URBAN



RURAL

200 In urban areas, traffic is slow and heavy. Traffic is faster and lighter in suburban areas. In rural areas, traffic is generally light. Whatever the traffic conditions, the driver has the responsibility to be careful and alert at all times.

201 DRIVING OVERSEAS

Most countries in Europe adopt a left hand drive system, ie. you'll find the steering wheel on the other side of the car.

For more information on overseas driving tips, please refer to the Automobile Association of Singapore's website. Being prepared will allow you to drive more confidently.

DRIVING UPHILL

202 On approaching a hill or incline, accelerate to a speed higher than when travelling on a flat road to go up the hill.

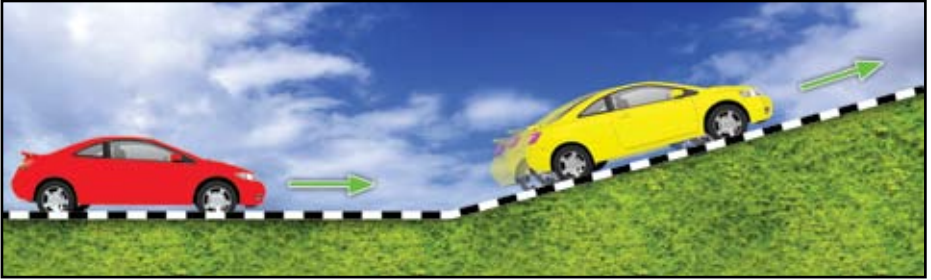

203 Should the vehicle show signs of losing speed, quickly change to a lower gear and accelerate.



204 If the hill is steep, shift to the second or first gear before going up. It would be difficult to change gears while on the hill. The vehicle may roll backwards when you change gears. Do not drive too close to the vehicle in front.



DRIVING IN TRAFFIC

- 205** Be very careful as you approach the top of the hill as you cannot see what is approaching from the other side of the hill. You should keep to the left and proceed carefully. Do not drive too close to the vehicle in front.



DRIVING DOWNHILL

- 206** Choose an appropriate gear before you drive down a hill. Use the third or the second gear on a low hill. On a steep hill, use the second or the first gear.



(a) On a low, downhill slope, use the third or the second gear.



(b) On a steep downhill slope, use the second or the first gear.

- 207** It is far better to use the 'engine-brake' than the foot-brake over a long distance downhill as using the foot-brake will cause the brakes to overheat and 'fade'. Use the foot-brake only when necessary.



- 208** When descending, the ascending vehicle has the right of way. Keep a greater following distance when driving downhill.

PARKING ON A SLOPE

209 Park your vehicle close to the edge of the road and pull the handbrake up fully.



- (a) Turn your front wheels outward when facing uphill so that if your vehicle slides downwards, it will be stopped by the kerb.

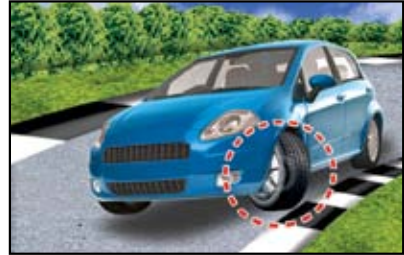

- (b) When facing downhill turn your front wheel inward.



- (c) Engage the 1st gear if your vehicle is parked facing uphill.

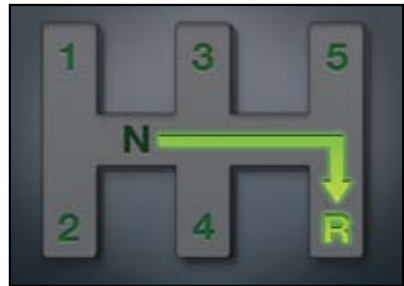

- (d) Engage the reverse gear if your vehicle is parked facing downhill.



- (e) If necessary, use a wedge to prevent the vehicle from sliding downwards.



- (f) Do not park your vehicle on a slope that is too steep.

INTERACTION WITH OTHER ROAD USERS

210 Knowledge and compliance of the highway code is essential for safe driving. To prevent accidents, you should watch for tell-tale signs which indicate traffic hazards and react accordingly. Give other road users time and space to complete whatever they are doing.

THE VEHICLE IN FRONT

211 When driving forward:

- (a) Position yourself on the road so that you can see most of what the driver ahead is seeing;
- (b) Observe all vehicles, paying special attention to the vehicle in front;
- (c) Be alert for any changes in traffic situations or patterns;
- (d) Look out for brake warning lights and indicator lights on vehicles travelling in front of you. This should give you ample warning to react quickly.



212 (a) **Do not tailgate.** If you follow the vehicle in front too closely, your range of vision will be blocked by the vehicle in front due to your position;

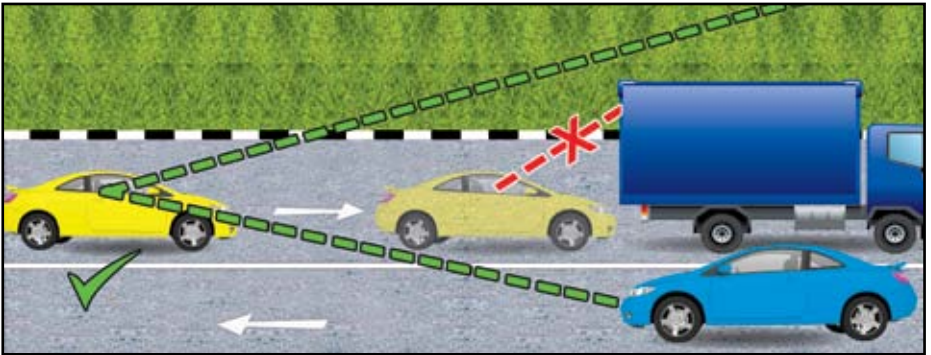

(b) Should the vehicle in front stop suddenly, an accident is unavoidable as you do not have enough reaction time and distance to brake.

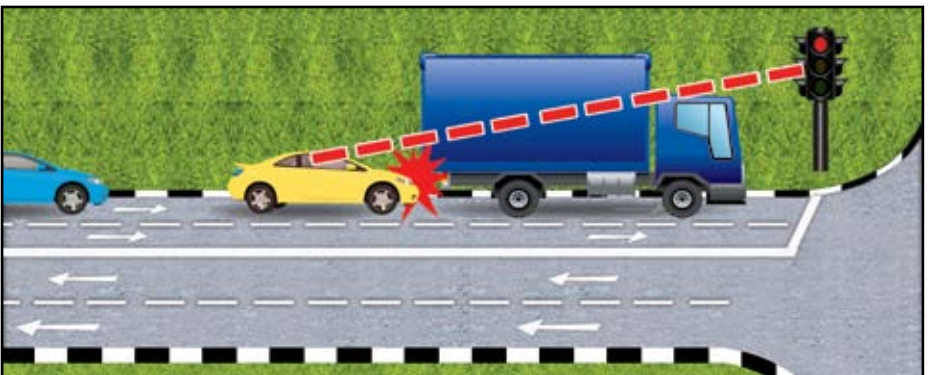

213 To be able to stop with an appropriate space between your vehicle and the vehicle in front, you must allow at least one car length for every 16km/h of your speed.

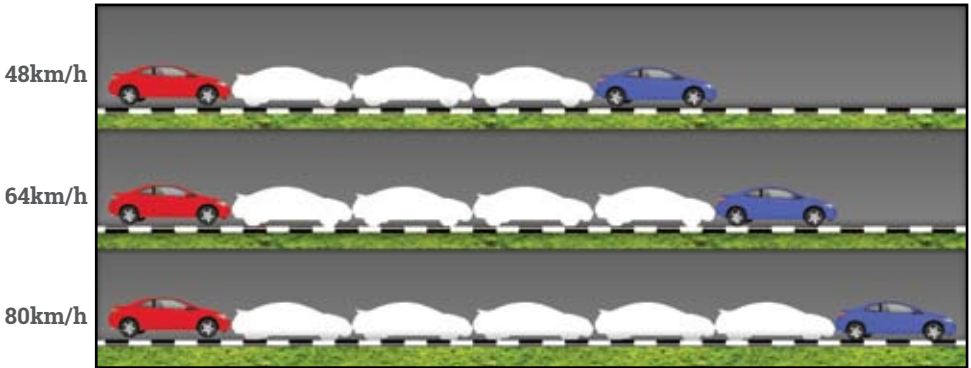

214 A simple way to ensure a safe gap between you and the vehicle in front is to use the 'two-second' rule. As the vehicle in front of you passes a stationary object, such as a lamp post on the side of the road, start counting to yourself 'one-thousand-and-one, one thousand-and-two'. This will take you 2 seconds. If you reach the same spot before you finish these eight words, you are following too closely and it is necessary to slow down. This rule will keep you at a safe following distance and will apply to all types of vehicles at any speed.

" One thousand and one, one thousand and two "

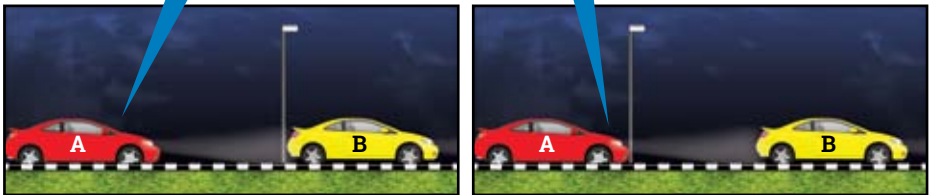

(Vehicle 'A' does not pass the lamp post before counting "one-thousand-and-one, one-thousand-and-two". Thus vehicle 'A' is at a safe following distance from vehicle 'B')

215 Be aware of the traffic behind you by checking the rear view mirror inside the vehicle as well as the wing mirrors from time to time. Check your blind spots by turning your head to look over your shoulder before switching lanes. Do not swing out, change lane or stop suddenly or at short notice. Show clear and correct signals to inform the vehicle behind of your intentions.



THE ONCOMING VEHICLE

216 Always look far ahead, analyse the road in front of you and anticipate any problem you might have with the oncoming vehicle. If an oncoming vehicle from an adjacent lane signals to change lane, do not accelerate, instead slow down and leave a gap for the vehicle to enter your lane.



TRAFFIC JAM

217 (a) In a traffic jam, be patient; sounding the horn or shouting will not ease the jam.



(b) Stay in your lane. Do not weave in and out of slow moving traffic.

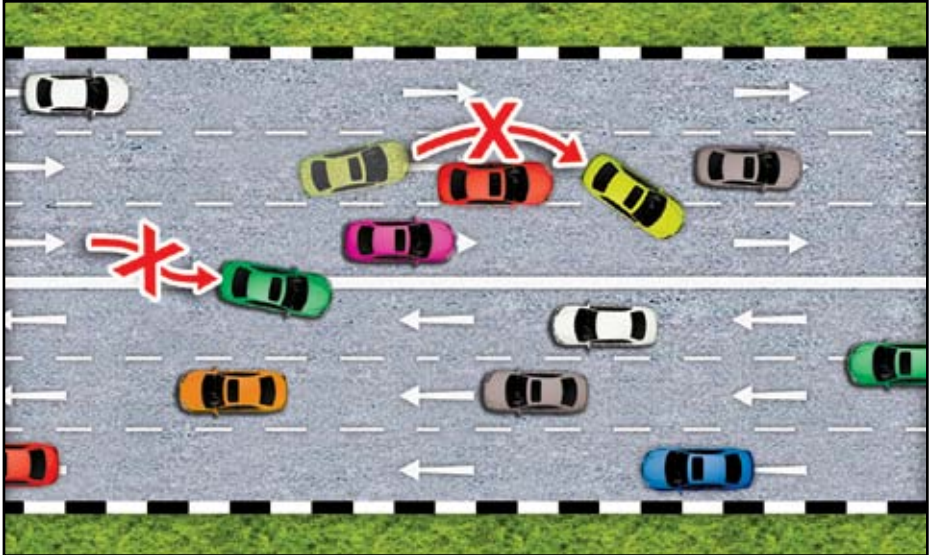

(c) Show courtesy to vehicles in the minor road by allowing them to join the main traffic stream.



DRIVING IN TRAFFIC

218 To avoid getting into a traffic jam, you should:

- plan your route before setting out;
- avoid congested roads when travelling;
- avoid peak hour driving when most roads are congested;
- give yourself plenty of time for each journey. You will be less anxious and more patient when driving;
- turn on your car radio for announcements of accidents, jams, etc. and follow instructions so as to avoid such roads;
- refer to the Electronic Signs Boards for traffic information and react accordingly.



STATIONARY VEHICLES

219 When there are several stationary vehicles on the left lane, do not weave in and out. Use the next lane on the right instead and move back to the left lane after you have passed them.

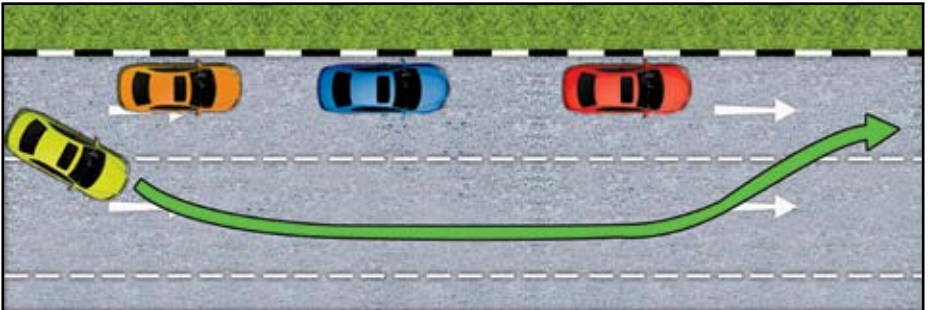

220 When passing stationary vehicles on a two-way road, give way to oncoming vehicles from the opposite direction.

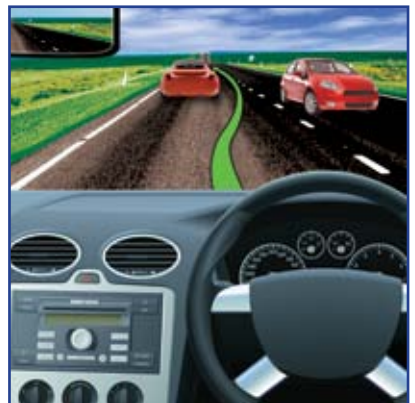

- 221 When passing by a parked vehicle, look out for drivers or passengers opening the doors of their vehicles and keep a safe gap of about 1 meter between you and the parked vehicles.



- 222 Always be prepared for vehicles pulling out from the side of the road or a parking lot. Both the presence of a driver in a vehicle and smoking exhaust are indicators that the vehicle may move off. Be ready to slow down or stop.



- 223 At a bus stop, be alert and prepared to stop for pedestrians, especially school children, as they may dash out from the front of a bus or between buses.



OBSTACLES

224 When approaching road works, look out for workers, equipment and materials lying on the road. If the obstruction is on your side of the road, give way to oncoming vehicles from the opposite direction before passing.



225 Slow down to the speed at which you can stop at a safe distance of one vehicle length from the obstacles should the need arises to give way to the oncoming vehicles.



226 When passing fixed obstacles, keep a gap of at least 0.5 metres from them.



227 When passing moving vehicles, keep a gap of at least 1.5 metres from them.



PEDESTRIANS

- 228** Accidents involving pedestrians often result in serious injury or even death. Pedestrians, especially the very young and the very old, are the most vulnerable group of road users. It is your duty as a driver to protect pedestrians.
- 229** Young children below the age of fifteen are prone to accidents. This is because they are impulsive, playful, curious and unaware of the dangers on the road.

Be very careful when driving near schools, playgrounds and in residential areas. Be especially alert when driving near ice-cream sellers and road side vendors. Always keep a look-out for children who may run or dash across the road.



- 230** The old and the handicapped are vulnerable to accidents on the roads. It is a known medical fact that upon reaching the age of 50 years, a person's
- (a) vision begins to fade;
 - (b) hearing is impaired;
 - (c) body weakens and reflexes become slower.

Aged and handicapped persons are usually slow in reacting to traffic situations. Therefore when approaching the old or the handicapped, give them plenty of room and stop if necessary for them to cross the road.

- 231** Jaywalkers cross the road anywhere they please, heedless of traffic rules and vehicles. Be on the look-out for them.



232 Joggers may run or dash across the road unexpectedly without any regard for vehicles on the road. Always be alert and give way to them if necessary.



233 Pedestrians have the right of way at a Zebra Crossing. Zig-zag lines are drawn on the road to give you advance warning of the Zebra Crossing ahead.

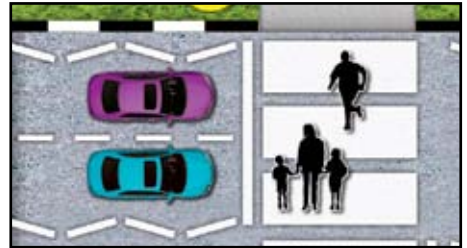

234 When stopping for pedestrians to cross, stop well before the stop line.

On approaching a Zebra Crossing, slow down and look out for pedestrians crossing the road. Do not park, overtake or accelerate within the area marked by the zig-zag lines.

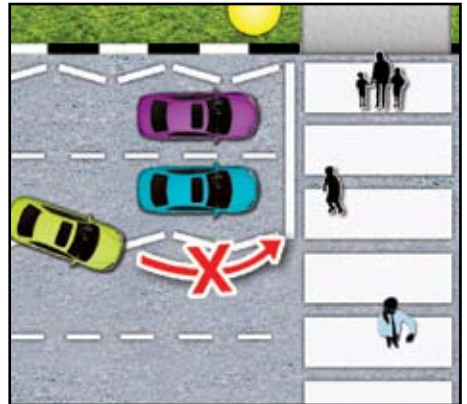

235 When the visibility of a zebra crossing is poor, Pedestrian Crossing Ahead Markings (PCAMs) are painted on the road to alert you that a zebra crossing is hidden out of sight.



236 A vehicle slowing down or stopping near or at the zebra crossing may indicate that pedestrians are crossing the road; approach cautiously and stop if necessary.

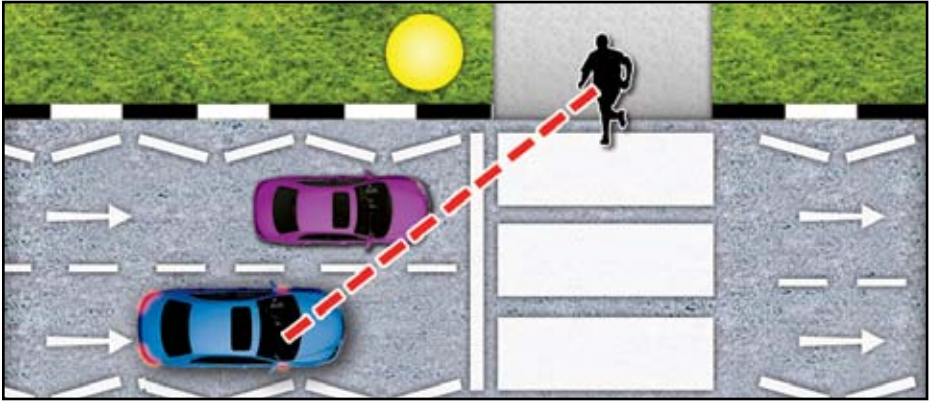

237 When you are at or near a Pedestrian Crossing at controlled junctions:

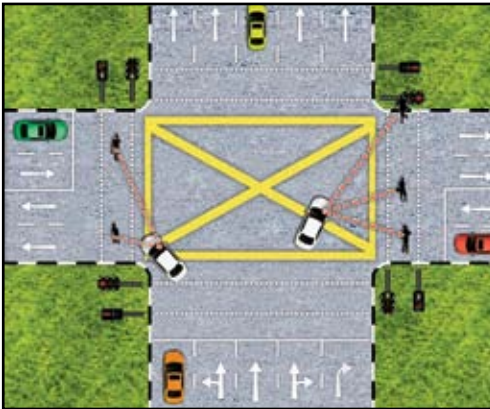

(a) Observe pedestrian movements;

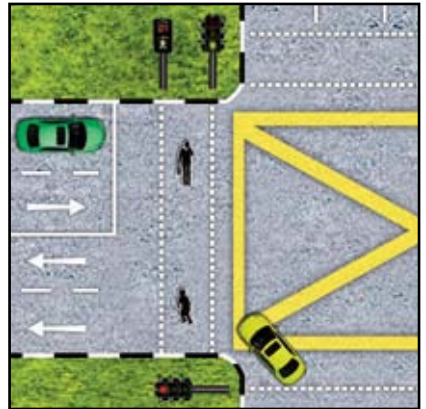

(b) Always give way to them;



(c) Do not overshoot the stop line so as not to obstruct the passage of pedestrians.

DRIVING IN TRAFFIC

238 If pedestrians use the centre of the road as a refuge when crossing, drive slowly and allow ample clearance between them and your vehicle. Do not drive too close to them as it may force them to move backwards into the path of other vehicles.



239 When you are turning into a side road, look out for pedestrians.

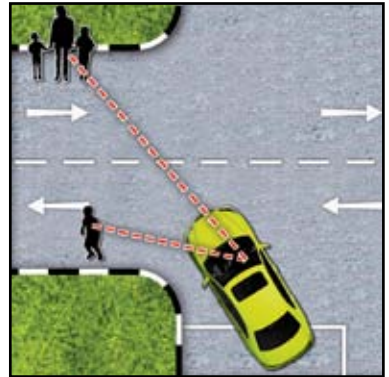

240 Motorists turning left to join the main traffic from a side road should look out for pedestrians from the left.

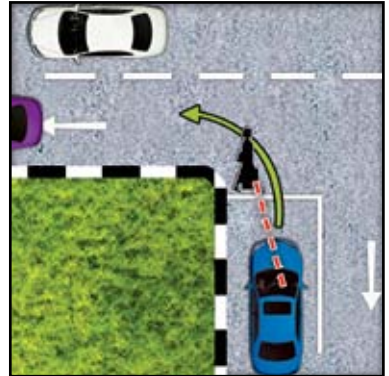

241 On a road without a pavement or pedestrian footpath, do not drive too close to the pedestrians.



242 When pedestrians are facing traffic, keep a gap of at least 1 metre from them.



243 When pedestrians are turned away from traffic, keep a gap of at least 1.5 metres from them.



244 When driving through puddles of water, drive slowly so as to prevent splashing the water onto pedestrians who may be nearby.



CYCLISTS

245 Give cyclists plenty of room and be alert when approaching or passing them. Be ready to slow down or stop when you see a cyclist glancing behind him/her. This is an indication that he/she may change direction at any moment. Look out for cyclists:

- (a) riding into your path suddenly;
- (b) riding against the flow of traffic;

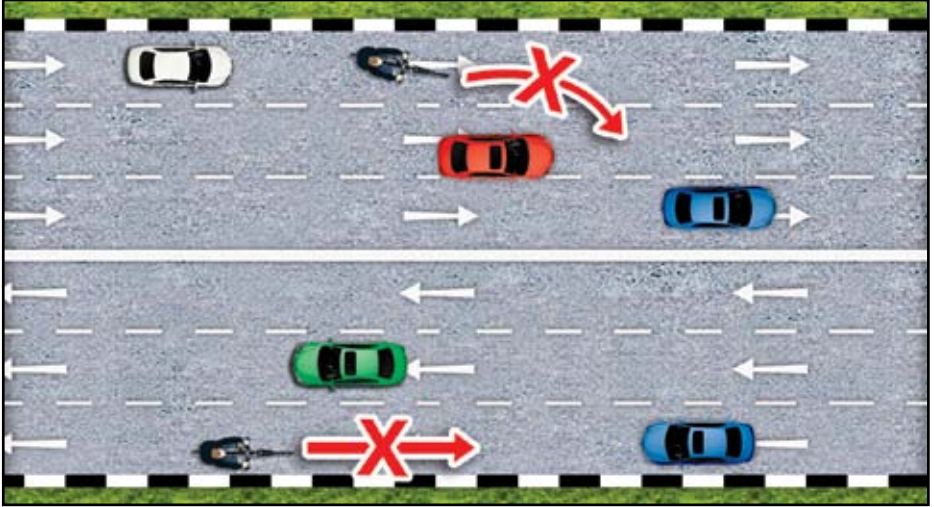

- (c) Riding in a wobbling fashion when carrying a pillion rider or a heavy load. Keep a wider gap from such a cyclist.

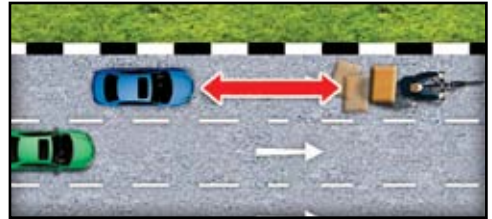

246 When turning,

- (a) check your mirrors and blind spots;
- (b) look out for cyclists between you and the kerb;
- (c) do not make a sharp turn as you may knock the cyclist down. Slow down and give way to the cyclist if it is not safe to turn.



247 When overtaking, keep a safe distance between your vehicle and the cyclist and do not cut in sharply after overtaking the cyclist.



248 When parking, watch out for passing cyclists when opening the door of your vehicle.



MOTORCYCLISTS

249 Motorcyclists, due to their small size and fast speed, are sometimes not clearly visible. Always be on the look-out for them. Give way to them as they are easily injured should they fall. Do not insist on the right on way.

250 Motorcyclists may not be aware of your intention to pull out. Allow them to pass first before pulling out.

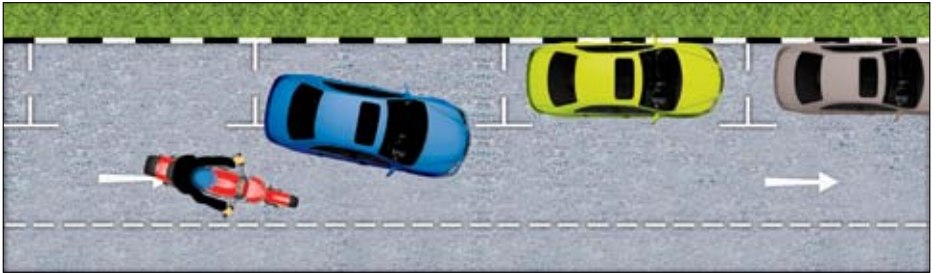

251 When slowing down or stopping, beware of motorcyclists who tailgate. Signal your intention early so as to avoid getting hit from behind.

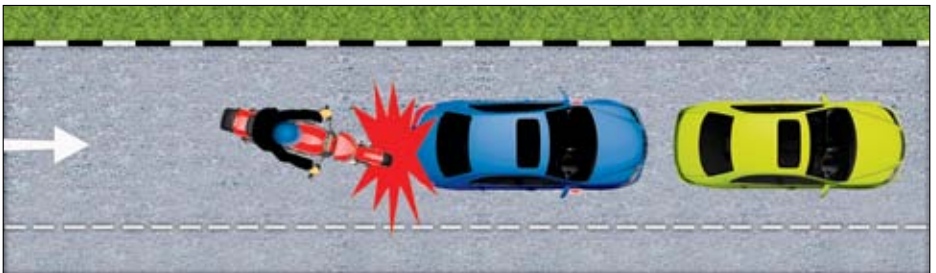

252 Motorcyclists going through sandy or wet patches on the road may lose control. Slow down and be prepared to stop if necessary.



253 Motorcyclists approaching you at a bend from the opposite side may glide into your path. Give them plenty of room by keeping further to your left.



254 Always check for motorcyclists riding in your 'blind spot' before you change directions.

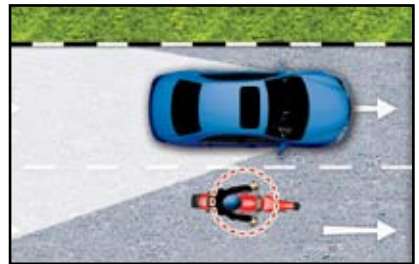

EMERGENCY VEHICLES

255 Emergency vehicles such as fire-engines, ambulances and police vehicles on call must be given priority to move ahead quickly and safely. Any indication of their approach, such as sirens or flashing lights, should prompt you to give way by moving to the left, slowing down or stopping if necessary.

LARGE VEHICLES

256 Accidents involving large vehicle are normally very serious or fatal. Bear in mind these factors when you encounter large vehicles on the road:

- (a) They are high, long and bulky and block your view;
- (b) They need plenty of space to turn;
- (c) Their speed is restricted because of their size and load.

257 Keep between you and the large vehicle a greater following distance than you normally would with other vehicles. Your view of the road ahead will be blocked if you are too close to the large vehicle.

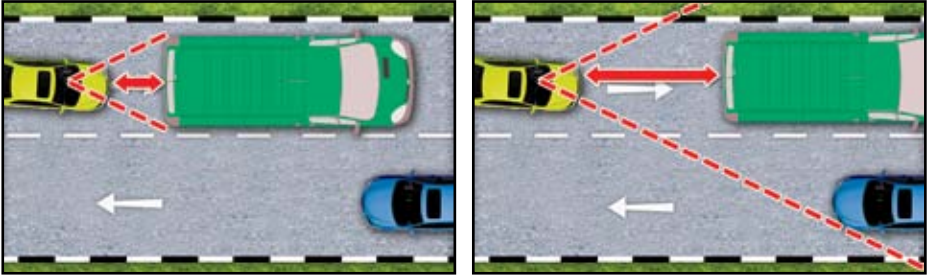

258 You will not be able to react in time should goods fall off a loaded vehicle if you are following it too closely.



259 Large vehicles may not be able to turn left without first moving to the right, or turn right without first moving to the left. As such, watch out when large vehicles are turning.

Do not try to pass them on the side which they intend to turn into.

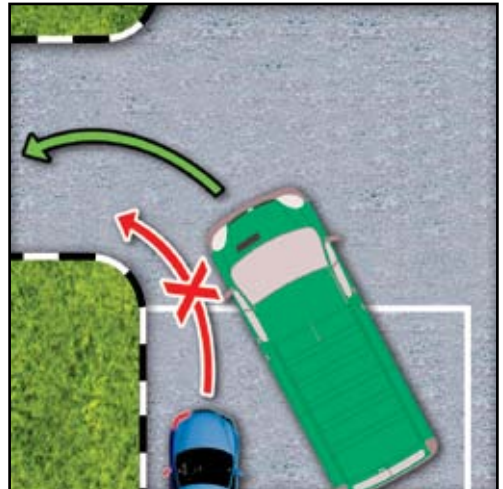

EXPRESSWAYS

260 Expressways are designed for unimpeded, smoother and faster traffic flow than on ordinary roads. On expressways, you have to react earlier and faster to traffic situations. Therefore it is very important that you concentrate and be alert while driving on expressways.

261 In order not to impede the smooth traffic flow, the vehicles listed below are prohibited on expressways:

- (a) Bicycles
- (b) Tricycles
- (c) Invalid carriages
- (d) Trishaws
- (e) Motorcycles with side-cars
- (f) Motorcycles which are propelled by electric motors
- (g) 3-wheeled vans
- (h) Low trailers
- (i) Vehicles driven by learner drivers
- (j) Road rollers
- (k) Ready-mix concrete trucks
- (l) Mobile cranes
- (m) Forklifts
- (n) Excavators
- (o) Road pavers
- (p) Tractors
- (q) Dumpers
- (r) Wheel loaders
- (s) Bulldozers
- (t) Graders
- (u) Mobile concrete pumps
- (v) Hydrant dispensers
- (w) Electric bicycles (E-bikes)

262 To join the expressway, signal your intention once you are on the slip road leading to it. Build up your speed to that of vehicles on the expressway so that you can merge smoothly into the traffic stream on the expressway.



263 On the expressway, drive at a steady speed close to the speed limit of the expressway or the limit of your vehicle and keep a safe following distance between you and the vehicle in front. The speed limits of most expressways are 80 km/h and 90km/h. The speed limit of the KPE is 70 km/h or 80 km/h.

264 Observe the speed of your vehicle by glancing at the speedometer at regular intervals. Do not race with other vehicles or weave in and out of traffic.

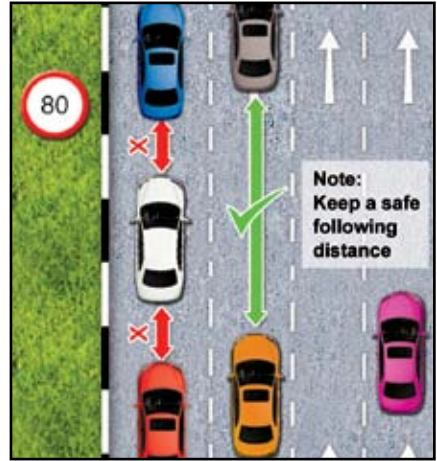

265 Do not use the right outermost lane unless overtaking another vehicle; it is meant for emergency vehicles and overtaking. If you do use it, return to the inner lane as soon as it is safe for you to do so.

266 Slower moving vehicles should keep to the left and not 'hog' the centre lanes. Road hogging holds up traffic and slows its flow; it also causes other faster moving vehicles to overtake dangerously on the left.

267 Do not stop or park on the expressway, including on the road shoulders. It is an offence to drive on the road shoulder of the expressway.

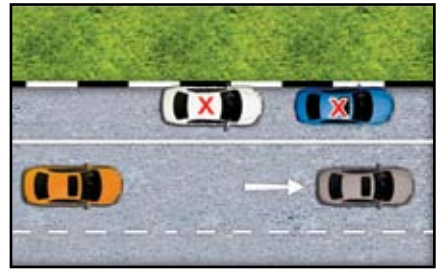

268 You may stop or park your vehicle on the road shoulder of the expressway in the event of a breakdown or accident.

269 Do not let down or pick up passengers on the expressway.

270 When leaving the expressway, plan your exit early, signal left and move into the left inner lane. Once you are on the deceleration lane, slow down to a speed suitable for the road you are joining. If you miss an exit, do not reverse but carry on to the next exit.

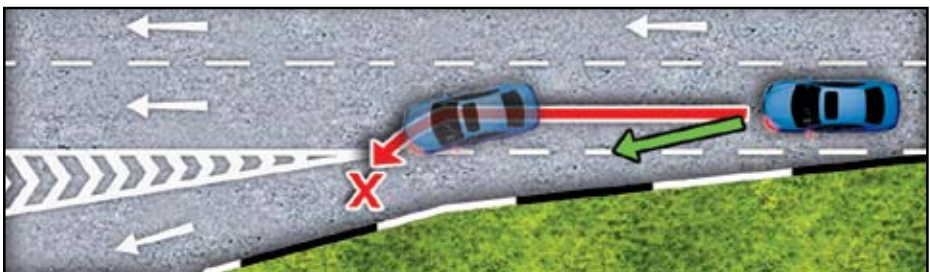

DRIVING IN TRAFFIC

271 Should your vehicle break down while on the expressway, switch on the hazard lights and if possible, move your vehicle off the carriageway onto the road shoulder. Do not step into the expressway and do ensure that passengers keep clear of the carriageway. Passengers and motorists are to stand behind vehicle impact guardrails while waiting for the rescue vehicle to arrive. Place a breakdown sign (an equilateral triangle) at a distance of 20 meters or more behind the vehicle as a warning to other drivers. Arrange to have your vehicle towed away as soon as possible as it is hazardous for it to remain on the road shoulder.



EMERGENCIES

272 Everyone hopes that he/she need not deal with difficult situations on the road. However, no one can predict when an emergency will arise, so be prepared for such incidents.

273 If a breakdown occurs unexpectedly while driving, the most important consideration is to retain control of the vehicle. Let other road users know that something is wrong by sounding the horn and switching on the headlight and hazard lights. Move to the side of the road after checking that it is safe to do so.

LOOSE BONNET

274 A bonnet which is not securely fastened may be lifted by the wind when travelling at a fast speed, thereby obstructing your view of the road ahead.

When this happens:

- remain calm;
- slow down by braking smoothly and progressively;
- stop by the side of the road to close the bonnet.



DRIVING IN TRAFFIC

SHATTERED WINDSCREEN

275 Windscreens are sometimes shattered by stones or hard objects flung from the wheels of other vehicles or from the loose loads of lorries. Do not follow too closely behind lorries carrying load or gravel. Also, stay further behind other vehicles when travelling on stony roads. If the windscreen shatters:

- remain calm;
- turn on the hazard lights;
- slow down and move to the side of the road;
- stop at the road side and remove the shattered screen and broken bits of glass;
- do not use your bare hands to take away the glass. Use a rag or cloth;
- drive slowly to the workshop.



ENGINE OVERHEATING

276 Overheating of the engine could be due to a leak in the radiator or a snapped fan belt. Indications of an overheated engine are a very fast idling speed and the temperature indicator moving into the red section of the gauge. When overheating occurs:

- switch on the hazard lights;
- slow down and drive safely to the side of the road and stop the vehicle;
- wait till the engine has cooled down. Open the radiator tank cap and top up with water or coolant. Do not open the radiator tank cap of a hot engine as steam will gush out and you are likely to get scalded.



FIRE

277 A short circuit in the electrical system of the vehicle can cause a fire. If this happens,

- stop your vehicle quickly by the side of the road;
- get all passengers out of the vehicle in an orderly manner;
- move them as far away as possible from the vehicle;
- use a fire extinguisher to put out the fire. If you do not have one or are unable to put out the fire, call the fire brigade. The telephone number of the Fire Brigade is 995.



STUCK ACCELERATOR PEDAL

278 If the accelerator is stuck,

- try to lift the pedal up with the toe of your shoe. Do not take your attention off the road.

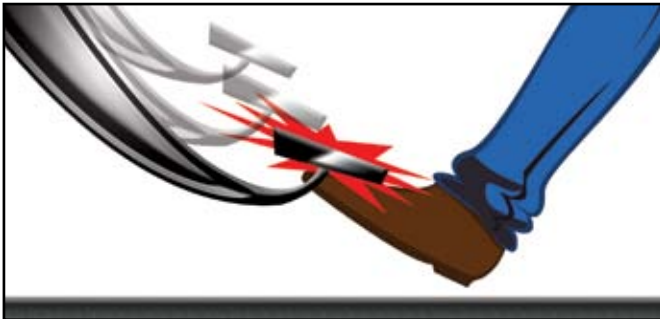

- If you cannot free the pedal in this manner, turn on the hazard lights and move the vehicle safely to the side of the road.
- Stop the vehicle and switch off the ignition.

FOOT-BRAKE FAILURE

279 In the event of a brake failure:



- (a) turn on the hazard lights and move safely to the side of the road;
- (b) apply the handbrake;
- (c) 'change down' quickly to a lower gear, preferably to the 2nd gear and release the clutch to use the engine brake;
- (d) switch off the engine.

LOOSE WHEEL

280 When any of the wheels are loose, the vehicle may wander from side to side, accompanied by excessive noise from the loose wheel. You will also have difficulty steering the vehicle. In such a situation, slow down, give the appropriate signal and stop at a safe spot by the side of the road. Tighten the loose wheel before proceeding.

TYRE BLOW-OUT

281 When a tyre blows out, there will be a strong pull on the vehicle towards the side of the blown tyre. The pull is greater for the front wheel than for the rear wheel. When this happens, tighten your grip on the steering wheel and steer against the pull to keep on course. Brake gently and progressively and stop the vehicle by the side of the road.

ACCIDENTS

282 There are three factors which contribute to a traffic accident:

- (a) The road users;
- (b) The environment;
- (c) The vehicle.

283 Of the three factors, nearly most of the traffic accidents are caused by road users and are due mainly to:

- (a) errors in judgement, especially by children and the elderly, and
- (b) driving without due care and attention.

284 Motorcyclists are the most vulnerable vehicle users, you should exercise caution especially when driving close to them.

285 Learn right from the beginning to cultivate the habit of driving carefully and attentively. Also make an effort to improve your judgement of speed and distance every time you drive.

286 When you are involved in an accident, you should stop irrespective of whether there is an injury or not. Remember to switch on the vehicle hazard lights to warn the other road users of the accident.

287 In an accident where there is no injury:

- (a) the drivers involved should move their vehicles quickly and safely to the road- side to avoid creating a hazardous situation for other road users;
- (b) both parties should settle the matter among themselves;
- (c) if the matter cannot be settled privately, both parties should inform their respective insurance companies of the accident;
- (d) it is not necessary to report the accident to the police.

288 In an accident where there is injury:

- (a) seek help from passers-by to warn other road users of possible obstruction(s) or danger arising from the accident;
- (b) call for the police and the ambulance;
- (c) do not move or remove your vehicle without the authority of a police officer, unless:
 - (i) the injured person has to be conveyed to a hospital;
 - (ii) it is necessary to extricate a trapped person, to prevent a fire, or reduce serious traffic hazards as a result of the accident;
- (d) inform your insurance company of the accident.

THE DRIVING TEST

TEST APPOINTMENT

- 289** To take the driving test you have to make an appointment for the test in advance. Upon payment of a test fee you will be given a receipt showing the time and date of your driving test and the centre where the test will be conducted. On the day of your test, hand the following to the person-in charge at the reception counter for driving tests:
- (a) Valid provisional driving licence;
 - (b) Valid insurance certificate of the vehicle to be used for the test;
 - (c) Valid final driving theory certificate;
 - (d) Receipt for the driving test fee.
- 290** You must also bring along your Identity Card for identification purposes. If you are a foreigner you must produce your Passport. You cannot make an appointment for the test if you have accumulated 13 or more demerit points for traffic offences. Even though you have registered for the test, you will not be allowed to sit for it if you have 13 or more demerit points.

THE PRACTICAL TEST

- 291** The driving test consists of two parts. The first part is a test of your driving skills and is conducted on a driving circuit. The second part is a test of your ability to interact safely with other road user and how you comply with and observe traffic rules and regulations; it is conducted on the roads.
- 292** During the test, the examiner will assess your driving performance with a Tablet PC or checklist. All possible driving errors are shown on the Tablet PC or checklist. If the learner commits any serious mistakes he/she fails the test immediately. For less serious mistakes he/she will accumulate penalty points ranging from 2 to 10 for each mistake. A learner who accumulates penalty points in excess of a predetermined number of points fails the test. Whether or not you succeed in your driving test, the test report or checklist used for the test will be given to you at the end of the test so that you can learn from and correct your mistakes.

RESTRICTIONS ON LEARNER DRIVERS

RESTRICTIONS ON LEARNER DRIVERS

293 Learners drivers are not allowed at all times at the following recreation parks and public car parks.

- (a) (i) Botanic Gardens
- (ii) East Coast Park
- (iii) Fort Canning Park
- (iv) Grounds of all Government Hospitals
- (v) Jurong Bird Park
- (vi) Kranji Reservoir Park
- (vii) Labrador Park
- (viii) Lower Pierce Reservoir Park
- (ix) MacRitchie Reservoir Park
- (x) Mount Faber Scenic Park
- (xi) Paris Ris Park
- (xii) Seletar Reservoir Park
- (xiii) Sembawang Park
- (xiv) Upper Pierce Reservoir Park
- (xv) Public Car Parks

RESTRICTION ON LEARNER DRIVERS

(b) Prohibited Area

Commencing at a point on the southern coast of the Island of Singapore where the production southwards of Alexandra Road meets the sea coast, the boundary runs along the aforesaid production of Alexandra Road to Alexandra Road, thence in succession along Alexandra Road, Queensway, Holland Road, Napier Road, Tanglin Road, Orange Grove Road, Anderson Road, Balmoral Road, Chancery Lane, Thomson Road, Braddell Road, Bartley Road, Upper Paya Lebar Road, Paya Lebar Road, Geylang Road, Tanjong Katong Road to the sea coast, which area is more particularly delineated and shown on the following map:

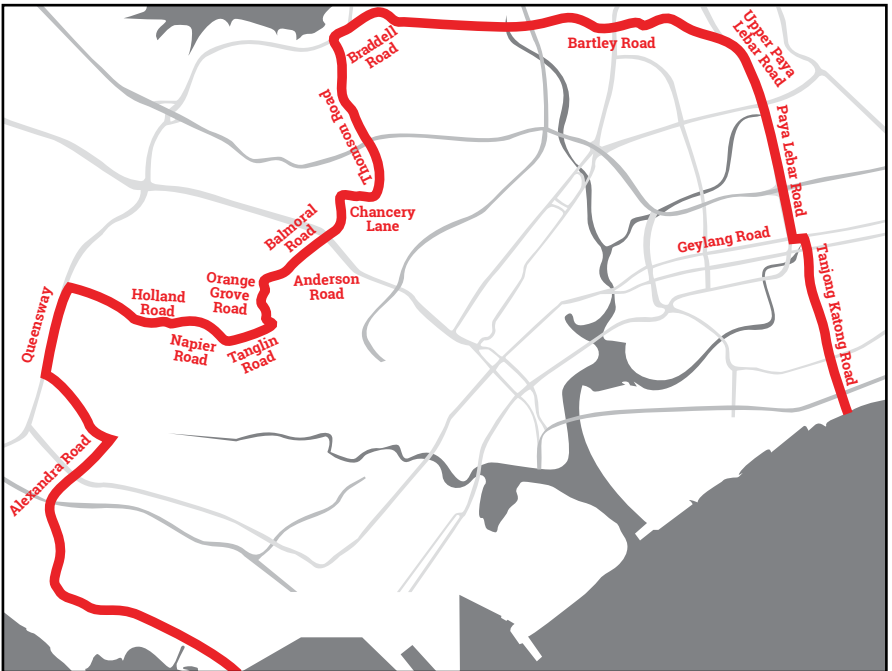

(c) Learner drivers are not allowed within the following areas during the times stated:

Weekdays (except on a gazetted public holiday) or a Sunday

7.30am - 9.30am

12.30 pm - 2.00pm

4.00pm - 7.00pm

Saturday

(if that Saturday is not a gazetted public holiday)

7.30am - 9.30am

12 noon - 2.00pm

VEHICLE MAINTENANCE

DAILY CHECKS

294 Before driving, spend a few minutes to check the following:

- (a) Ensure that the registration plates are clean and the numbers are easily distinguishable. It is an offence to drive without registration plates, one in front and another at the rear of the vehicle.
- (b) Look for any punctured tyre.
- (c) Ensure that all lights are working. It is an offence to drive a vehicle if any of the headlamps, rear lamps, stop lamps, reversing lamps, number plate lamps, direction indicators and reflectors are not working.
- (d) Both the front and rear windscreens must be kept clean. A dirty windscreen will reduce your visibility.
- (e) Look under the vehicle for signs of leakage of oil or water.
- (f) Turn the ignition key to the 'ON' position. Check that all warning lights and gauges on the instrument panel are in working order.
- (g) After having started the engine, move off slowly and check whether there are any strange noises or vibrations. Step on the foot brake to check whether the brakes are working and that the vehicle does not pull to the left or right. The steering wheel should not feel exceptionally heavy.

WEEKLY CHECKS

295 Weekly checks on your vehicle will contribute greatly to safer, trouble free and more pleasurable driving. When checking your vehicle pay attention to the following:

- (a) The radiator coolant is at the correct level and the radiator cap is tightly closed;
- (b) The windscreen cleaning liquid is at the correct level;
- (c) There is sufficient engine oil;
- (d) The battery terminals are tightly connected and the water in the battery is at the correct level;
- (e) The brake fluid is at the right level;
- (f) The air pressure of all tyres including the spare tyre is correct;
- (g) You should have a spare tyre, a jack and handle and a wheel-nut wrench inside the boot of your vehicle.

PERIODIC CHECKS

296 At recommended intervals by the manufacturer, send your vehicle to an authorised service station to have the following items checked, serviced and replaced:

- (a) Engine oil (d) Air Cleaner (g) Suspension
- (b) Oil filter (e) Chassis (h) Brake-linings
- (c) Gear-box oil (f) Ignition System

LIGHT GOODS VEHICLES

CAUSES OF ACCIDENTS

297 Pick-ups and panel-vans account for a large proportion of traffic accidents. These accidents are usually the result of:

(a) **Excessive Speed**

When pick-ups and panel-vans are not laden with goods they are capable of travelling at higher speeds and as such the steering and braking mechanisms of these vehicles may respond differently; thus, when not handled carefully, skidding or accidents may result.

(b) **Carrying Passengers In A Dangerous Manner**

When passenger are conveyed on a pick-up, they must be properly seated. Standing passengers can cause the vehicle to be unstable and unbalanced especially when turning and going round bends. A sudden stop may result in passengers being thrown from the vehicle.

SAFETY DEVICES

298 Owners of pick-ups and panel-vans are required by the law to have the following safety devices installed in their vehicles:

(a) **Speed Warning Device**

This device will give off a sound to warn the driver that the vehicle's speed has been exceeded.

(b) **Railings**

Pick-ups are required to install railings on both sides of the vehicle to secure goods.

SAFEGUARDING LIVES THROUGH ENFORCEMENT CAMERAS

Traffic Police (TP) will look into the deployment of more traffic sensors, such as speed and red-light cameras, to shape safer motorist behaviour. TP will explore placing additional cameras in accident-prone locations, in order to mitigate the risks of accidents occurring. The highly visible cameras will serve to deter the commission of traffic violations, thereby enhancing road safety.

RED LIGHT CAMERAS

299 To deter and detect motorists who endanger other road users by beating the red lights, a total of 240 digital red light cameras have been installed island-wide.

Traffic junctions that do not have red light cameras installed are monitored by TP's mobile enforcement operations. Such locations are regularly evaluated so that they remain relevant.

Motorists who beat red lights are liable for 12 demerit points and a fine of \$200 to \$230 depending on vehicle type. Motorists who are charged in court are liable to a \$1,000 fine or 3 months' imprisonment for the first offence, and a \$2,000 fine or 6 months' imprisonment for a second or subsequent offence.

FIXED SPEED CAMERAS

300 TP also employs various enforcement strategies to ensure that motorists comply with vehicle/road speed limits. These include the use of static digital speed enforcement cameras island-wide and the use of mobile speed laser cameras during anti-speed operations. In addition, patrol officers are continually on the lookout for speedsters who drive dangerously.

Motorists who commit speeding offences can be fined \$130 to \$200 and receive 4 to 24 demerit points. They may also be prosecuted in court.

MOBILE SPEED CAMERAS

301 TP is constantly exploring various technological solutions to complement its enforcement efforts. One of the options is to adopt Mobile Speed cameras (MSCs).

Similar to the functions of fixed speed cameras, the MSCs are meant to be more mobile, and provide a more ad-hoc solution, being able to be deployed to certain areas that the current fixed speed cameras may not be able to.

Deploying and redeploying of MSCs will be faster and more cost-effective than the fixed speed cameras, and also allow TP to respond promptly to curb localised and prolonged speeding problems, without compromising frontline resources from other TP operations.

Painted in the same traffic-orange colours, the cameras will act as deterrence to errant motorists and behaviours.

TP would like to urge all road users to adhere to traffic rules and regulations at all times and not only when there are enforcement cameras or police officers in sight. For the sake of your loved ones, make it home safely.



COURTEOUS DRIVING

Driving Along

- 302 Adjust your speed to the speed of the traffic around you so as to not slow down traffic behind you.
- 303 It is courteous to yield the right-of-way to others when circumstances permit.
- 304 When the right-of-way is given to you, it is gracious to say thank you.

Signalling

- 305 Give appropriate signals early to allow others to act on them in time.
- 306 Cancel your signals when they are not in use so as to not confuse others.

Use Of Horn

- 307 Sound the horn only to warn other road users of dangers such as a likely collision.
- 308 Do not use the horn to express anger or frustration.
- 309 Do not use the horn to demand the right-of-way or bulldoze your way through crowded places.

Lane Discipline

- 310 Keep to the left of the road and leave the other lanes for other faster moving vehicles to pass safely.
- 311 Keep within your lane. It is inconsiderate to straddle lanes as this would obstruct other vehicles and may lead to traffic being held up.
- 312 Do not weave in and out of traffic lanes as it would cause confusion and danger to others.
- 313 Cutting into the path of other vehicles is discourteous and likely to cause an accident.

At Road Junctions

- 314 Move into the correct lane early at road junction to let others know your intended direction of travel.
- 315 When making right turns, position your vehicle properly so that it does not hinder oncoming vehicles.

In Traffic Queues

- 316 Stay in queue during traffic hold-ups. Do not jump queue. Jumping queue would aggravate the traffic jam.
- 317 Leave a gap at the junction to a side road in traffic queues to enable vehicles from the opposite direction to turn right as well as for vehicle from the side road to move out.

Overtaking

- 318 Overtake only when it is absolutely necessary.
- 319 Overtake only when you are sure that there are no other vehicles attempting to pass or overtake you.
- 320 Slow down and keep left when being overtaken to allow the overtaking vehicle to pass quickly.
- 321 Accelerating when others are trying to overtake you is unsafe and not gracious.

Following Distance

- 322 Keep a safe following distance from the vehicle in front so as to allow yourself enough room to stop safely should the vehicle in front stop suddenly.
- 323 Do not harass the vehicle in front by tailgating it. This is a dangerous practice which could easily lead to an accident.
- 324 Flashing your headlights or blasting the horn at slower moving vehicles in front of you is rude.

Stopping And Parking

- 325 Always stop or park close to the edge of the road.
- 326 Always stop or park at places where you would not cause any inconvenience to other road users.
- 327 Do not stop your vehicle under a shade which is at a distance from a junction while waiting for the traffic signal to change. This is a selfish act and may slow down traffic at the junction.
- 328 When parking your vehicle in a parking lot, be considerate by parking your vehicle parallel to and in the centre of the lot.
- 329 Wait for your turn when looking for a parking lot. It is antisocial to jump queue or force your way into a lot when another vehicle is trying to get into the parking lot.
- 330 Do not drive if any of your vehicle's headlamps, tail-lamps and direction indicators are not working.
- 331 Dip your headlights when following other vehicles or facing oncoming vehicles to prevent dazzling the drivers of other vehicles.
- 332 In the daytime when visibility is poor, you should turn on the headlights so that you can see and be seen more easily.

Pedestrians And Cyclists

- 333 Give pedestrians and cyclists plenty of room as they might change direction suddenly.
- 334 Do not sound the horn when you are close to pedestrians as you might scare and cause them to react irrationally, resulting in an accident.
- 335 Do not obstruct pedestrians by stopping on the pedestrian crossing.
- 336 On wet roads, slow down when you are near pedestrians and cyclists so as to not splash them with water from the road.

Patience

- 337 Always be patient. Do not rush or lose your cool on the road.
- 338 It is not gracious to show any provocative gesture when other drivers do something wrong or cause inconvenience to you. No one would deliberately get himself/herself involved in an accident.

To Err Is Human: Apologise And Forgive

- 339 Indicate that you are sorry when you have caused inconvenience to others. This will soothe the other driver.

LAYOUT OF A DRIVING CIRCUIT

340

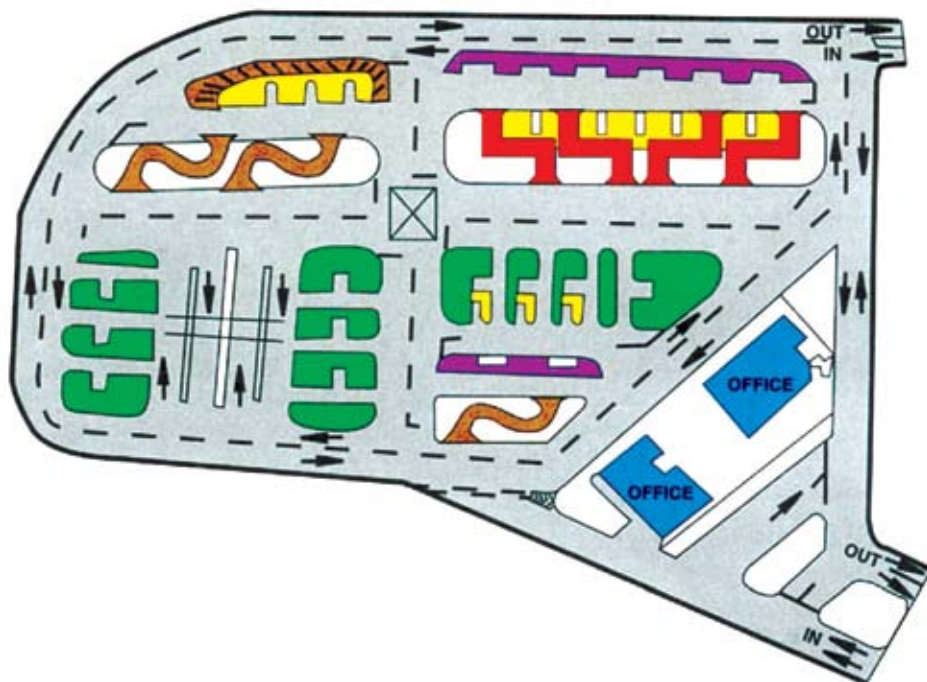

Crank-shaped Course



Parallel Parking Lot



S-shaped Course



Perpendicular Parking Lot

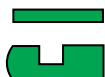

Directional Change Lot

